

# Preface

Thank you for purchasing the SD90 series AC drive developed by our company. SD90 series AC drive is a compact small power AC drive. It is an economic model specialized for the small automation equipments, especially for electronic equipments, food packaging, woodworking and other applications.

## SD90 Series AC Drive Features

### Advanced Vector Control Algorithm:

- ✦ Vector mode 0 control is more stable at low speed, high torque output at low frequency and better dynamic performance.

### Multiple Functions:

- ✦ Multi-stage speed control, simple PLC, PID and pulse counting control.

### Stable and Reliable Anti-trip Function:

- ✦ Stable and reliable overvoltage/overcurrent stalling control algorithm, non-stop control function to prevent frequent trip in complex applications.

This manual describes the functions and features and correct use of SD90 series AC drive, including product selection, parameter setting, running commissioning, troubleshooting and routine maintenance and other related matters. Please read this manual carefully to make sure the correct installation and operation and maintenance to achieve the high performance of this AC drive. Please hand this manual to the users and keepers of this AC drive.

## Unpacking Inspection Cautions

Every AC drive have been tested strictly in factory prior to shipment. Upon unpacking, check:

- ✦ Whether the product is damaged;
- ✦ Whether the nameplate model and AC drive ratings are consistent with your order.
- ✦ Whether the box contains the AC drive, certificate of conformity, user manual and warranty card. If you find any omission or damage, contact our company or your supplier immediately.

**First-time Use:**

For the users who use this product for the first time, read the manual carefully.

If in doubt concerning some functions or performances, please contact the technical support personnel of our company to ensure correct use.

**SD90 series AC drives have passed CE test and also meet the requirements of following International Standard.**

- ✦ IEC/EN 61800-5-1:2003 safety requirements for adjustable speed electric drive systems.
- ✦ IEC/EN 61800-3:2004 adjustable speed electric drive systems: The third part: the electromagnetic compatibility standard of the product and its specific test method.
- ✦ IEC/EN 61000-2-1,2-2,3-2,3-3,4-2,4-3,4-4,4-5,4-6:EMC International and EU Standard.

The instructions are subject to change, without notice, due to product upgrade, specification modification as well as efforts to increase the accuracy and convenience of the manual.

# Contents

<b>Preface</b> .....	01
<b>Contents</b> .....	03
<b>Chapter 1 Safety and Cautions</b> .....	05
1.1 Safety Cautions.....	06
1.2 Cautions.....	09
<b>Chapter 2 Product Information</b> .....	13
2.1 Naming Rules.....	14
2.2 Nameplate.....	14
2.3 SD90 Series of AC Drive.....	15
2.4 Technical Specifications.....	15
2.5 Product Outline and Installation Hole Size.....	17
2.6 Selection Units.....	19
<b>Chapter 3 Mechanical and Electrical Installation</b> .....	21
3.1 Mechanical Installation.....	23
3.2 Electrical Installation.....	25
<b>Chapter 4 Operation, Display and Application Examples</b> .....	35
4.1 Introduction of the keypad.....	36
4.2 Viewing and Modifying Function Codes.....	38
4.3 Structure of Function Codes.....	39
4.4 View status parameters.....	39
<b>Chapter 5 Function Parameter Table</b> .....	43
<b>Chapter 6 Parameter Description</b> .....	71
Group F00: Basic Function Group.....	72
Group F01: Start-stop Control Group.....	79
Group F02: Motor Parameter Group.....	85
Group F03: V/F Control Group.....	88

Group F04: Input Terminal Group.....	93
Group F05: Output Terminal Group.....	104
Group F06: HMI Group.....	110
Group F07: Enhancement Group.....	116
Group F08: PID Control Group.....	122
Group F09: Swing Frequency ,Fixed-length Count and Fixedtime.....	133
Group F0A: Simple PLC and Multi-stage Speed Control.....	135
Group F0B: Protection Parameter Group.....	141
Group F0C: Serial Communication Function Group.....	145
Group F0D: Status Check Function Group.....	148
<b>Chapter 7 Maintenance and Troubleshooting.....</b>	<b>151</b>
7.1 Routine Repair and Maintenance of the SD90.....	151
7.2 Warranty Agreement.....	153
7.3 This chapter Content.....	153
7.4 Alarm and Fault Indications.....	154
7.5 Fault Reset.....	154
7.6 Fault History.....	154
7.7 AC Drive Fault Instructions and Solutions.....	154
7.8 Common Faults and Solutions.....	157
<b>Chapter 8 Communication Protocol.....</b>	<b>159</b>
8.1 Networking Mode .....	160
8.2 Interface mode.....	160
8.3 Protocol Frame Format .....	160
8.4 Function Protocol.....	161
8.5 Communication Parameter Address.....	165

# Chapter 1

---

## Safety and Cautions

---

### Safety and Cautions Definition

Read this manual carefully so that you have a thorough understanding. Installation, commissioning or maintenance may be performed in conjunction with this chapter. Our company will assume no ability and responsibility for any injury or loss caused by improper operation.





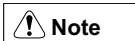



Indicates that failure to comply with the notice will result in severe personal injury or even death.







Indicates that failure to comply with the notice will result in personal injury or property damage.

## 1.1 Safety Cautions

Use Stage	Safety Grade	Precautions
Before Installation	 <b>Danger</b>	<ul style="list-style-type: none"> <li>+ Do not install the equipment if you find water seepage, component missing or damage upon unpacking.</li> <li>+ Do not install the equipment if the packing list does not conform to the product you received.</li> </ul>
	 <b>Danger</b>	<ul style="list-style-type: none"> <li>+ Handle the equipment with care during transportation to prevent damage to the equipment.</li> <li>+ Do not use the equipment if any component is damaged or missing. Failure to comply will result in personal injury.</li> <li>+ Do not touch the components with your hands. Failure to comply will result in static electricity damage.</li> </ul>
During Installation	 <b>Danger</b>	<ul style="list-style-type: none"> <li>+ Install the equipment on incombustible objects such as metal, and keep it away from combustible materials. Failures to comply may result in a fire.</li> <li>+ Do not loosen the fixed screws of the components, especially the screws with the red marks.</li> </ul>
	 <b>Note</b>	<ul style="list-style-type: none"> <li>+ Do not drop wire end or screw into the AC drive. Failure it will result in damage to the AC drive.</li> <li>+ Install the AC drive in places free of vibration and direct sunlight.</li> <li>+ When two AC drives are laid in the same cabinet ,</li> <li>+ arrange the installation positions properly to ensure the cooling effect.</li> </ul>

Use Stage	Safety Grade	Precautions
At wiring	 <b>Danger</b>	<ul style="list-style-type: none"> <li>✦ A circuit breaker must be used to isolate the power supply and the AC drive. Failure to comply may result a fire.</li> <li>✦ Ensure that the power supply is cut off before wiring. Failure to comply may result in electric shock.</li> <li>✦ Never connect the power cables to the output terminals(U,V,W) of the AC drive. Pay attention to the marks of the wiring terminals and ensure correct wiring. Failure to comply may result in damage to the AC drive.</li> <li>✦ Ensure that the main cable line comply with the standard, the line meets the EMC requirements and the area safety standard. Failure to comply may result in risk or accident.</li> <li>✦ Never connect the power cables the braking resistor between the DC bus terminals P+, P-. Failure to comply may result in a fire.</li> <li>✦ Use a shielded cable for the encoder, and ensure that the shielding layer is reliably grounded.</li> </ul>
Before Power-on	 <b>Danger</b>	<ul style="list-style-type: none"> <li>✦ Please confirm the peripheral equipment and cable converter is configured in this manual of the recommended model, all the configuration line in accordance with the connection method of the manual provides the correct wiring. Failure to comply will result in accidents.</li> <li>✦ Check that the voltage class of the power supply is consistent with the rated voltage class of the AC drive.</li> </ul>

Use Stage	Safety Grade	Precautions
After Power-on	 <b>Danger</b>	<ul style="list-style-type: none"> <li>✦ Do not open the AC drive's cover after power-on. Failure to comply may result in electric shock.</li> <li>✦ Do not touch the operation of AC drive during the hands is wet. Failure to comply will result in accident.</li> <li>✦ Do not touch any I/O terminal of the AC drive. Failure to comply may result in electric shock.</li> <li>✦ Do not change the default settings of the AC drive. Failure to comply will result in damage to the AC drive.</li> <li>✦ Do not touch the rotating part of the motor during the motor auto-tuning or running. Failure to comply will result in accident.</li> </ul>
During Operation	 <b>Danger</b>	<ul style="list-style-type: none"> <li>✦ Signal detection must be performed only by qualified personnel during operation. Failure to comply will result in personal injury or damage to the AC drive.</li> <li>✦ Do not touch the fan or the discharging resistor to check the temperature. Failure to comply will result in personal burnt.</li> </ul>
	 <b>Danger</b>	<ul style="list-style-type: none"> <li>✦ Avoid objects falling into the AC drive when it is running. Failure to comply will result in damage to the AC drive.</li> <li>✦ Do not start or stop the AC drive by turning the contactor ON/OFF. Failure to comply will result in damage to the AC drive.</li> </ul>
During Maintenance	 <b>Danger</b>	<ul style="list-style-type: none"> <li>✦ Do not repair or maintain the AC drive at power-on. Failure to comply will result in electric shock.</li> <li>✦ Ensure that the AC drive is disconnected from all power suppliers before starting repair or maintenance on the AC drive.</li> </ul>



Use Stage	Safety Grade	Precautions
During Maintenance	 <b>Danger</b>	<ul style="list-style-type: none"> <li>✦ Repair or maintenance of the AC drive may be performed only by qualified personnel. Failure to comply will result in personal injury or damage to the AC drive.</li> <li>✦ Set and check the parameters again after the AC drive is replaced.</li> </ul>

## 1.2 Cautions

### 1.2.1 Motor Insulation Test

Perform the insulation test when the motor is used for the first time, or when it is reused after being stored for a long time, or in a regular check-up, in order to prevent the poor insulation of motor windings from damaging the AC drive during the insulation test. A 500-V mega-Ohm meter is recommended for the test. The insulation resistance must not be less than 5MΩ.

### 1.2.2 Thermal Protection of Motor

If the selected AC drive does not match the rated capacity of the motor, especially when the rated power of the AC drive is higher than that of the motor, adjust the parameters for motor protection in the AC drive or to install thermal relay to protect the motor.

### 1.2.3 Running Below and Above Rated Frequency

The AC drive provides frequency output of 0 to 600.00Hz. When the users use the frequency converter for a long time, please pay attention to the motor cooling or use of variable frequency motor. If the AC drive is required to run at over 50Hz, consider the capacity of the machine.

### 1.2.4 Motor heat and noise

The output of the AC drive is pulse width modulation (PWM) wave with certain harmonic frequencies, and therefore, the motor temperature, noise, and vibration are slightly greater than those when the AC drive runs at power frequency (50Hz).

### 1.2.5 Voltage-sensitive device or capacitor on output side of the AC drive

Do not install the capacitor for improving power factor or lightning protection voltage sensitive resistor on the output side of the AC drive because the output of the AC drive is PWM wave. Otherwise, the AC drive may suffer transient overcurrent or even be damaged.

### 1.2.6 Contactor at the I/O terminal of the AC drive

When a contactor is installed between the input side of the AC drive and the power supply, the AC drive must not be started or stopped by switching the contactor on or off. If the AC drive has to be operated by the contactor, ensure that the time interval between switching is at least one hour since frequent charge and discharge will shorten the service life of the capacitor inside the AC drive.

When a contactor is installed between the output side of the AC drive and the motor, do not turn off the contactor when the AC drive is active. Otherwise, modules inside the AC drive may be damaged.

### 1.2.7 When External Voltage is Out of Rated Voltage Range

The AC drive must not be used outside the allowable voltage range specified in this manual. Otherwise, the AC drive may be damaged. If required, use a corresponding voltage step-up or step-down device.

### 1.2.8 The Derating of the AC Drive

Different power grade frequency converter has its default carrier frequency, when to run at a higher carrier frequency, the AC Drive must to reduce the amount when running.

### 1.2.9 Prohibition of Three-Phase Input Change into Two-Phase Input

Do not change the three-phase input of the AC drive into two-phase input. Otherwise, a fault will result or the AC drive will be damaged.

### 1.2.10 Surge Suppressor

The AC drive has a built-in over-voltage, over-current device for suppressing the surge voltage generated when the inductive loads around the AC drive are switched on or off. If the inductive loads generate a very high surge voltage, use a surge suppressor for the inductive load to prolong the service life of the AC drive.

### 1.2.11 Ambient Temperature and De-rating

The normal use of the frequency converter ambient temperature is  $-10^{\circ}\text{C}\sim 40^{\circ}\text{C}$ . Temperature exceeds  $40^{\circ}\text{C}$ , the equipment need to reduce the amount of use. The ambient temperature of each increase is reduced by 1.5%, the maximum use of the ambient temperature is  $50^{\circ}\text{C}$ .

### 1.2.12 Altitude and De-rating

In places where the altitude is above 1000m and the cooling effect reduces due to thin air, it is necessary to de-rate the AC drive. Contact our company for technical support.

### 1.2.13 Disposal

The electrolytic capacitors, plastic parts and other devices may explode when they are burnt. Poisonous gas is generated when they are burnt. Treat them as ordinary industrial waste according to relevant national laws and regulations.

### 1.2.14 Adaptable Motor

- ✦ The standard adaptable motor is adaptable four-pole squirrel-cage AC asynchronous induction motor or PMSM. For other types of motor, select a proper AC drive according to the rated motor current.
- ✦ The cooling fan and rotor shaft of general motor are coaxial, which results in reduced cooling effect when the rotational speed declines. If variable speed is required, add a more powerful fan or replace it with variable-frequency motor in applications where the motor runs at low frequency for a long time.
- ✦ The standard parameters of the adaptable motor have been configured inside the AC drive. It is still necessary to perform motor auto-tuning or modify the default values based on actual conditions. Otherwise, the running effect and protection performance will be affected.
- ✦ The AC drive may alarm or even be damaged when short-circuit exists on cables or inside the motor. Therefore, perform insulation short-circuit test when the motor and cables are newly installed or during routine maintenance. During the test, make sure that the AC drive is disconnected from the tested parts.





# Chapter 2

## Product Information

---

### **This Chapter Content**

This chapter briefly introduces the operation principle, product performance, layout, nameplate, and type of instructions.

## 2.1 Naming Rules

Model code contains product information. Users can find the code on the model designation label attached to the AC drive or the simple nameplate.

SD90    -2S    0.7    G    C  
 ①            ②            ③            ④            ⑤

Name	Mark	Description	Detail
AC drive series	①	SD90 series	Sinodrive90 abbreviates Sd90
Voltage level	②	Voltage level	2S: Single-phase 220V Range:-15%~20% 4T: Three-phase 380V Range:-15%~20%
Adaptable power	③	Adaptable motor power(KW)	0.4KW~4.0KW
Load type	④	Load type	G: General type
Braking unit mark	⑤	Braking unit	Null: None C: With a brake unit

Fig. 2-1 Name Designation Rules

## 2.2 Nameplate

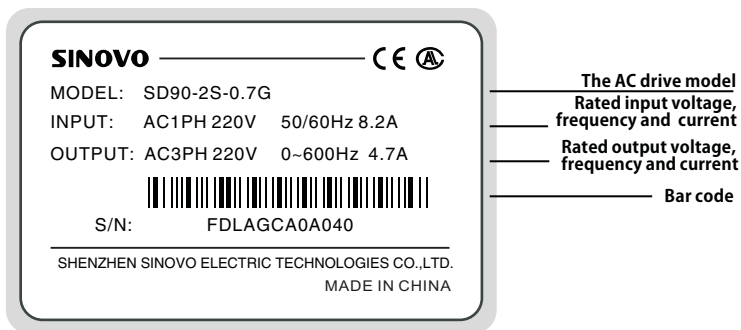

Fig. 2-2 Product nameplate

## 2.3 SD90 Series AC Drive

Table 2-1 SD90 series model

AC Drive Model	Power Capacity (KVA)	Rated Input Current (A)	Rated Output Current (A)	Adaptable Motor (KW)
Input voltage: single-phase 220V		Range : -15%~20%		
SD90-2S-0.7G	1.5	8.2	4.7	0.75
SD90-2S-1.5G	3.0	14.0	7.5	1.5
SD90-2S-2.2G	4.0	23.0	10.0	2.2
Input voltage: three-phase 380V		Range: -15%~20%		
SD90-4T-0.7G	1.5	3.4	2.3	0.75
SD90-4T-1.5G	3.0	5.0	3.7	1.5
SD90-4T-2.2G	4.0	5.8	5.1	2.2
SD90-4T-4.0G	5.9	10.5	8.5	4.0

## 2.4 Technical Specifications

Table 2-2 Technical specifications of Sd90

Item	Specifications				
Basic specifications	Maximum frequency	0~600Hz			
	Carrier frequency	2.0kHz~10.0kHz The carrier frequency is automatically adjusted based on the load features.			
	Input frequency resolution	Digital setting: 0.01Hz	Analog setting: Max frequency×0.025%		
	Control mode	0: V/F control; 1: Vector mode 0 control			
	Startup torque	1.0Hz/150%			
	Speed range	1:50 (Vector mode 0)			
	Overload capability	15 overload capability 60m for 120%; 60s for 150% f rated current; 4s for 180% of rated current			
	Torque boost	Auto torque boost	Manual torque boost 0.1% to 20%		
	V/F curve	Line	Multi-point	Square V/F curve	V / F separation
	Acc/Dec curve	Linear Acc/Dec mode; Four kinds of Acc/Dec time; Range of Acc/Dec Time: 0.0 ~ 3600.0s			

Table 2-2 Technical specifications of SD90 (Continued)

	Item	Specifications
Basic specifications	DC braking	DC braking frequency: 0.00Hz~Maximum frequency Braking time: 0.0 ~ 120.0s Braking action current value: 0.0~150%
	Jog control	Jog frequency range: 0.00Hz~Maximum frequency
	Onboard PID	It realizes process-controlled closed loop PID control system easily
	Simple PLC, Multi-stage	16-speed operating through built-in PLC or control terminal
	Auto voltage regulation (AVR)	It can keep constant output voltage automatically when the mains voltage changes.
	Overvoltage/ Overcurrent stall control	The current and voltage are limited automatically during the running process so as to avoid frequent tripping due to overvoltage/overcurrent.
	Rapid current limit function	It helps to avoid frequent over-current faults of the AC drive.
Individualized	High performance	High-performance current vector control technology to achieve a three-phase AC induction motor control.
	Instantaneous non-stop	Load feedback energy compensates the voltage reduction so that the AC drive can continue to run in a short time in case of power interruption.
	Rapid current limit	Rapid software and hardware current limiting technology helps to avoid frequent over-current fault.
Running	Bus support	In accordance with international standard MODBUS communication
	Command source	Given the control panel, control terminal, serial communication port given. It can be switched by a variety of ways.
	Frequency source	9 frequency sources : digital setting, analog voltage setting, analog current setting, pulse setting, 485 communication setting, etc. It can be switched by a variety of ways
	Auxiliary frequency source	9 auxiliary frequency source. Flexible implementation of auxiliary frequency tuning, frequency synthesis.
	Input terminal	Five digital input terminals (S1~S5). One analog input terminal (Ai1) that supports 0~10V voltage input or 0~20mA current input. One high-speed pulse (HDI) that receives max 50kHz frequency high-speed input.
Output terminal	One digital output terminal. One relay output terminal. One analog output terminal AO that supports 0~20mA current output or 0~10V voltage output	



Table 2-2 Technical specifications of SD90 (Continued)

Item		Specifications
Running	Key Locking and function selection	Achieve some or all of the keys locked and define the scope of partialkeys to prevent misuse.
	Protection function	Powered motor short circuit test; Input/output phase failure protection; Over current protection; voltage protection; Under voltage protection; Over heat protection ; Overload protection; braking resistor fault protection.
Environment	Installation location	In-door, free from direct sunlight, dust, corrosive gas, combustiblelega , oil mist, steam , water drop and salt .
	Altitude	Lower than 1000m (1000m-3000m for derated use)
	Ambient temperature	-10 +40 (derated use in the ambient temperature of40°C and 50°C )
	Humidity	Less than 95%RH, without condensing
	Vibration	Less than 5.9m/s2(0.6g)
Storage temperature		- 20°C to + 60°C

## 2.5 Product Outline and Installation Hole Size

### 2.5.1 Product Outline

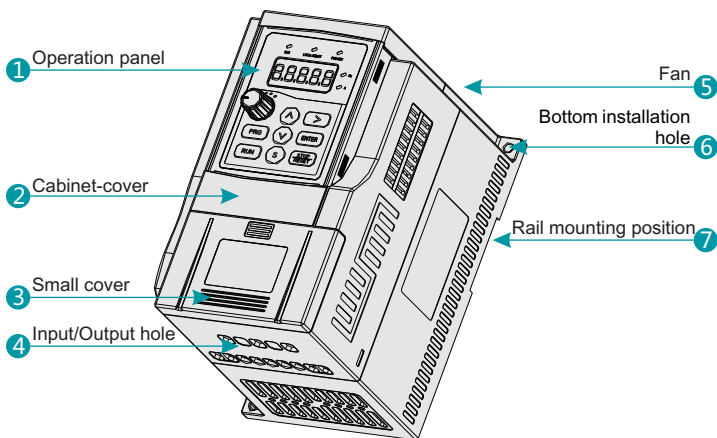

Fig. 2-3 The outline of AC drive

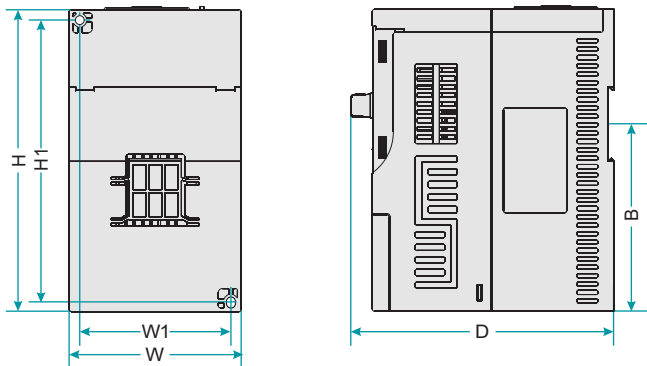

Fig. 2-4 Outline dimension and installation size

## 2.5.2 Installation Hole Size of the AC Drive

Table 2-3 SD90 AC drive's outline dimensions and installation sizes

Model	H(mm)	W(mm)	D(mm)	H1(mm)	W1(mm)	B(mm)	Diameter (mm)	GW(kg)
Single-phase 220V series								
SD90-2S-0.7G	145	82	115	135	72	89	Ø4	0.90
SD90-2S-1.5G								
SD90-2S-2.2G	190	110	152	178	98	*	Ø5	1.95
Three-phase 380V series								
SD90-4T-0.7G	145	82	115	135	72	89	Ø4	0.90
SD90-4T-1.5G								
SD90-4T-2.2G								
SD90-4T-4.0G	190	110	152	178	98	*	Ø5	1.95

### 2.5.3 External Keyboard Dimension

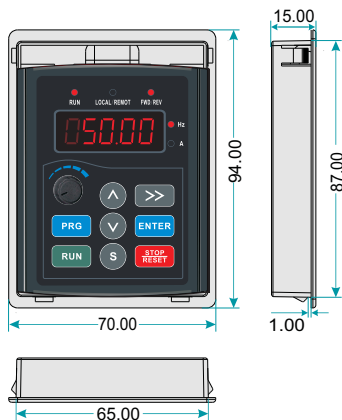

Fig. 2-5 External Keyboard dimension

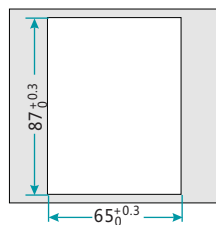

Fig. 2-6 Opening dimension diagram for keypad with base

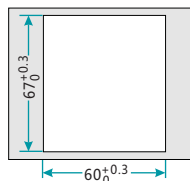

Fig. 2-7 Opening dimension diagram for keypad without base

## 2.6 Selection Braking Unit

The section recommend braking assembly is instructional data. Users can select different resistance value and power according to actual situation (Resistance value can not be lower than the recommended ones, the power can be higher than recommended ones). Brake resistance can be selected according to the power of motor in actual applied system. They are also related to system inertia, deceleration time and potential energy load, etc. Customs should select the AC drive according to actual situation. The bigger of the system inertia, the shorter of the deceleration time, the more frequent of the braking, and the braking resistance should select larger power and smaller resistance .

### 2.6.1 The Selection of Resistance Value

When braking, almost all renewable energy consumption of the motor is on the braking resistor. According to the formula:

$$U \cdot U / R = P_b$$

- U Braking voltage at stable braking system. (System selections differs in braking voltages. The AC380V system usually selects DC 700V braking voltage.)
- Pb Braking power.

### 2.6.2 The Selection of Brake Resistor Power

Theoretically braking resistance is in the same power as brake's, but considering the derating 70%. According to the formula::

$$0.7 \cdot Pr = Pb \cdot D$$

- Pr Resistor power.
- D Braking frequency (The reproduction process accounts for the proportion of the entire working process)

Elevator-20%~30%

Centrifuge-50%~60%

Accidental braking load-5%

Commonly take 10%

Table 2-4 Selecting brake unit

Model	Power	Resistance	Brake unit	Notes
Single-phase 220V series				
SD90-2S-0.7G	80W	≥150Ω	Built-in as standard	None
SD90-2S-1.5G	100W	≥100Ω		
SD90-2S-2.2G	100W	≥70Ω		
Three-phase 380V series				
SD90-4T-0.7G	150W	≥300Ω	Built-in as standard	None
SD90-4T-1.5G	150W	≥220Ω		
SD90-4T-2.2G	300W	≥220Ω		
SD90-4T-4.0G	300W	≥130Ω		



**Chapter 3**

**Mechanical and Electrical Installation**

---

 **Danger**

- ✦ Only qualified electricians are allowed to carry out what described in this chapter. Please operate according to the section of "pay attention to security matters", failure to these may cause personal injury or damage to equip
- ✦ Input power line is only allowed permanent fastening connection, and the equipment must be reliable grounding.
- ✦ Even if the inverter is in non-working state, the following terminal may still have dangerous voltage:
  - Power supply terminals: L1, L2, L3, P, Pb.
  - Terminals for connecting motor: U, V, and W.
- ✦ Waiting for 10 minutes after the power switch is off. And then you allow to install when the AC drive discharges completely.
- ✦ The minimum cross-sectional area of the grounding conductor must be equal to or greater than that of the power supply cable.

 **Note**

- ✦ Install the AC drive on incombustible objects such as metal. Failure to comply will result in a fire.
- ✦ If install two or more AC drives in a cabinet body, you should install cooling fan first and the air temperature is less than 45°C. Overheating will cause a fire or damage to equipment.
- ✦ The installation and design of the AC drive must comply with relevant laws and regulations of the installation region. If the installation of the AC drive violates the requirements of local laws and regulations, We our company does not assume any legal responsibility. In addition, if user are not comply with the recommendations, the AC drive may appear some faults not covered by the warranty.

## 3.1 Mechanical Installation

### 3.1.1 Installation Environment

- ① Ambient temperature: Ambient temperature has great influence on the service life of AC drives, so the ambient temperature should be within the range of  $-10^{\circ}\text{C}$  to  $50^{\circ}\text{C}$ .
- ② Install the AC drive on the surface of an incombustible object, and ensure that there is sufficient space around for heat dissipation. Install the AC drive vertically on the support with screws.
- ③ Install in the place where is not easy to vibrate and far away from the punching machine, etc. Vibration is equal to or less than 0.6G.
- ④ Free from direct sunlight, high humidity and condensation.
- ⑤ Free from corrosive, explosive and combustible gas.
- ⑥ Free from oil dirt, dust and metal powder.

### 3.1.2 Installation Location Tips

Ensure that there is sufficient space around for heat dissipation when installed SD90 series AC drives. Space reserved requirements as shown below:

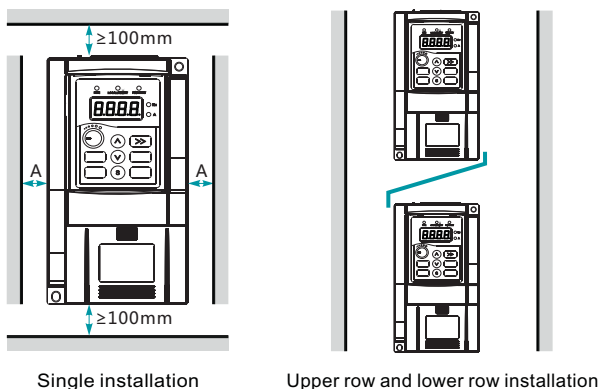

Fig. 3-1 Installation Diagram

#### Note:

install an insulation guide plate for upper row and lower row installation of the AC drive.

### 3.1.3 Installation Precautions

When you install SD90 series AC drive, pay attention to the following:

- ① Reserve the installation clearances as specified in Figure 3-1 to ensure sufficient space for heat dissipation. Take heat dissipation of the other parts in the cabinet into consideration.
- ② Install the AC drives upright to facilitate heat dissipation. If multiple AC drive are installed in the cabinet, install them side by side. If one row of AC drives need to be installed above another row, install an insulation guide plate, as shown in Figure 3-1.
- ③ Use incombustible installation support.
- ④ In the applications where there are metal powder, install the heatsink outside the cabinet and ensure that the room inside the fully-sealed cabinet is as large as possible.

### 3.1.4 Install and Remove the Cover

SD90 series AC drives use plastic housing, please refer to following 3-2 figure for the dismantle of open cover. Remove the upper cover by pushing the hook of the front cover inward, so as to eject the upper cover.

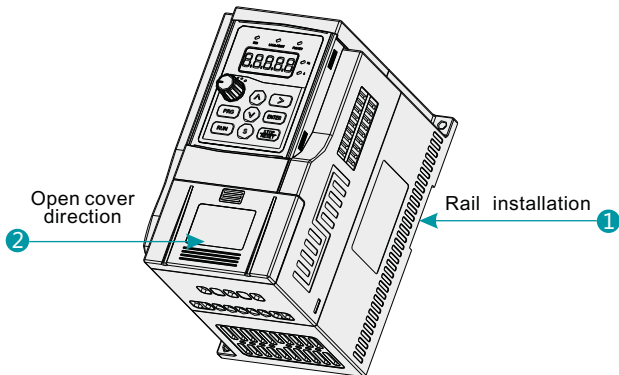

Fig.3-2 Remove the plastic lower cover

#### Note:

Remove the lower cover by pushing the hook of the lower cover inward symmetrically, so as to eject the cover .



## 3.2 Electrical Installation

### 3.2.1 Selection of Peripheral Electrical Components

AC Drive Model	MCCB (A)	Contactor (A)	Input Side Main Circuit Wire (mm <sup>2</sup> )	Output Side Main Circuit Wire (mm <sup>2</sup> )	Control Circuit Wire (mm <sup>2</sup> )
Single-phase 220V series					
SD90-2S-0.7G	16	10	2.5	2.5	0.75
SD90-2S-1.5G	20	16	4.0	2.5	1.5
SD90-2S-2.2G	32	20	6.0	4.0	1.5
Three-phase 380V series					
SD90-4T-0.7G	10	10	2.5	2.5	0.75
SD90-4T-1.5G	16	10	2.5	2.5	0.75
SD90-4T-2.2G	16	10	2.5	2.5	0.75
SD90-4T-4.0G	25	16	4.0	4.0	1.5

### 3.2.2 Description of Peripheral Electrical Components

Part	Mounting Location	Function Description
MCCB	Power receiving side	<ul style="list-style-type: none"> <li>✦ Interrupt the power supply when overcurrent occurs on the downstream devices.</li> </ul>
Contactor	AC drive input side	<ul style="list-style-type: none"> <li>✦ Start and stop the AC drive. Do not start and stop the AC drive frequently by switching the contactor on and off (less than twice per minute) nor use it to directly start the AC drive.</li> </ul>
EMC input filter	Between MCCB and the AC drive input side	<ul style="list-style-type: none"> <li>✦ Reduce the external conduction and radiation interference of the AC drive.</li> <li>✦ Decrease the conduction interference flowing from the power end to the AC drive and improve the anti-interference capacity of the AC drive.</li> </ul>
AC output reactor	Between the AC drive output side and motor, close to the AC drive.	<ul style="list-style-type: none"> <li>✦ Generally, the output side of the AC drive has much higher harmonics. When the motor is far from the AC drive, there is much distributed capacitance in the circuit and certain harmonics may cause resonance in the circuit, bringing about the following two impacts:               <ul style="list-style-type: none"> <li>✦ a) Degrade the motor insulation performance and damage the motor in the long run.</li> </ul> </li> </ul>

Part	Mounting Location	Function Description
AC output reactor	Between the AC drive output side and motor, close to the AC drive.	<p>b) Generate large leakage current and cause frequent AC drive protection trips.</p> <p>✦ If the distance between the AC drive and the motor exceeds 100m, instal an AC output reactor.</p>

### 3.2.3 Three-phase Input Wiring Mode

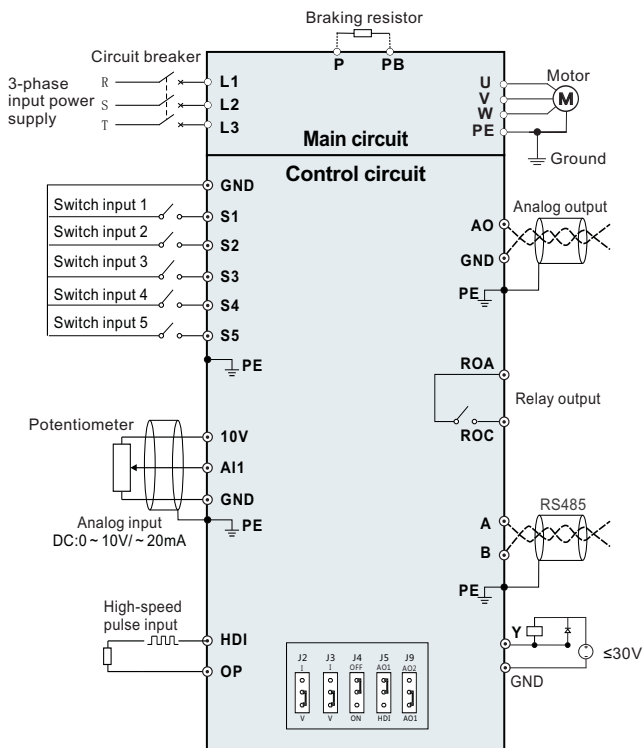

Fig. 3-3 Basic Wiring Schematic Diagram (1)

## 3.2.4 Single-phase Input Wiring Mode

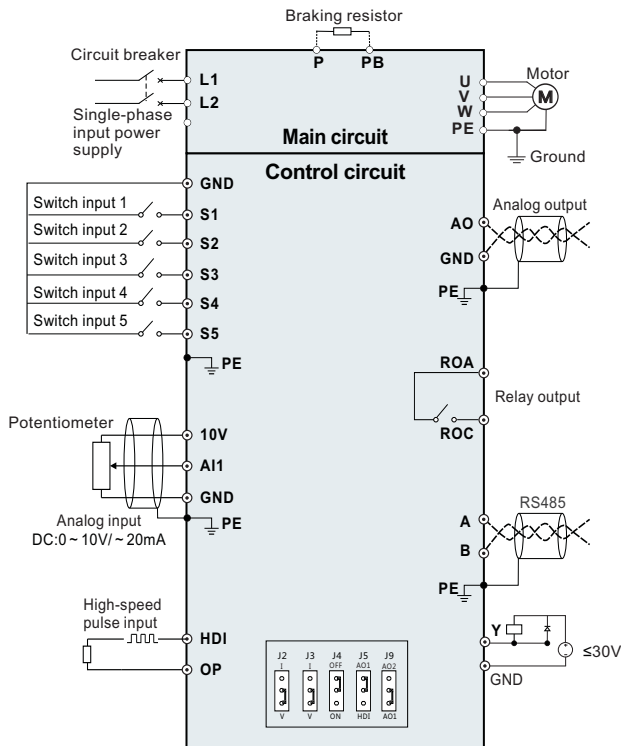

Fig.3-4 Basic Wiring Schematic Diagram (2)

**Precautions on the wiring:**

- ① DC bus have residual voltage after the AC drive is switched off. Ensure voltage is less than 36V before touching the equipment. Otherwise, you may get electric shock.
- ② Braking resistor connecting terminals:
  - a. The connecting terminals of the braking resistor are effective only for the AC configured with the built-in braking unit.

b. The cable length of the braking resistor shall be less than 5m. Otherwise, it may damage the AC drive.

③ The AC drive output terminals: U, V, W

a. The capacitor or surge absorber cannot be connected to the output side of the AC drive. Otherwise, it may cause frequent AC drive fault or even damage the AC drive.

b. If the motor cable is too long, this will damage the motor insulation or generate higher leakage current, causing the AC drive to trip in overcurrent protection. If the motor cable is greater than 30m, need to reduce the carrier to decrease the leakage current; if it is greater than 50 m long, an AC output reactor must be installed close to the AC drive.

④ Protective grounding terminal PE: Must be reliably connected to the main grounding conductor. Grounding wire diameter should be greater than 10mm<sup>2</sup> and the resistance must be less than 5Ω. Otherwise, it may cause electric shock, mal-function or even damage to the AC drive. Do not connect the grounding terminal to the neutral conductor of power supply.

### 3.2.5 The main circuit terminals and function

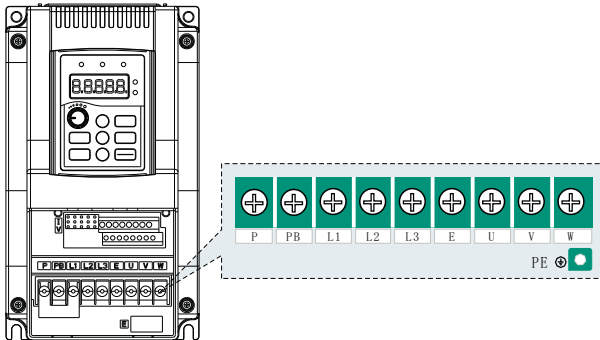

Fig.3-5 SD90 main circuit terminals diagram

The description of main circuit terminals

Terminal	Terminal Name	Description
L1, L2, L3	Power input terminal	Single-phase 220V/3-phase 380V AC power supply connect point
P, PB	Braking resistor connecting terminal	Braking resistor connecting terminal
U, V, W	AC drive output terminal	Connect 3-phase motor
PE	Ground terminal	Ground terminal

**Precautions on the wiring:**

- ① Power input terminals L1,L2,L3
  - ◆ The cable connection on the input side of the AC drive has no phase sequence requirement.
- ② Brake resistor terminal P, PB
  - ◆ Braking resistor model selection refers to recommended value. The cable length of the braking resistor shall be less than 5 m. Otherwise, it may damage to the AC drive.
- ③ The output side U, V, W
  - ◆ The capacitor or surge absorber cannot be connected to the output side of the AC drive. Otherwise, it may cause frequent AC drive fault or even damage the AC drive.
  - ◆ If the motor cable is too long, electrical resonance will be generated due to the impact of distributed capacitance. This will damage the motor insulation or generate higher leakage current, causing the AC drive to trip in overcurrent protection. If the motor cable is greater than 100 m long, an AC output reactor must be installed close to the AC drive.
- ④ Protective grounding terminal PE
  - ◆ This terminal must be reliably connected to the main earthing conductor. Otherwise, it may cause electric shock, mal-function or even damage to the AC drive.
  - ◆ Do not connect the grounding terminal to the neutral conductor of power supply.

## 3.2.6 Control circuit terminals and function

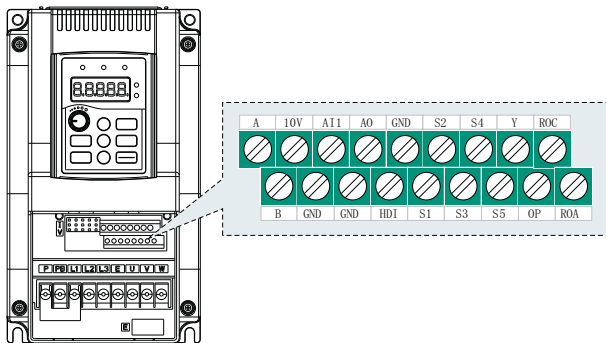

Fig-3-6 SD90 control circuit terminals diagram

## Function Description of Control Circuit Terminals



Type	Terminal	Name	Function Description
Analog input	10V	Analog input Reference voltage	10.5V( $\pm 3\%$ ) Max output current: 25mA, external potentiometer resistance range is more than 4k $\Omega$
	AI1	Analog input	0~20mA: input impedance 500 $\Omega$ , maximum input current is 25mA
			0~10V: input impedance 100 $\Omega$ , max input voltage 12.5V Input range: 0~10 V / 0~20 mA, switched by jumper J3 on the control board and factory defaulted as voltage input.
Analog output	AO	Analog output	0~20mA: impedance 200 $\Omega$ ~500 $\Omega$
			0~10V: impedance: > 10k $\Omega$
			Output range: 0~10 V / 4~20 mA, switched by jumper J2 on the control board and factory defaulted as voltage output.
Digital input	GND	Analog ground	The public ground of digital input terminals (S1-S5)
	S1-S5	DI-Digital Input 1 ~ 5	The specific function of multi-functional input terminals is set by F04.01~F04.05 It's valid when terminals and the GND are closed.
DI-Digital output	Y	Open collector output	Voltage range: 0~24V
			Current range: 0~50mA

Function Description of Control Circuit Terminals (Continued)

Type	Terminal	Name	Function Description
Relay output	ROA, ROC	Relay output	Normally open contact
			Contact capacity: 250VAC/3A, 30VDC/3A
High speed pulse	HDI, OP	High-speed pulse input	Pulse input: maximum frequency 50kHz
			Voltage range:10V~30V
RS485	A	485 differential signal +	Speed rate:1200/2400/4800/9600/19200/38400  Using twisted pair or shielded cable. The longest distance is 300 meters.
	B	485 differential signal -	
	GND	485 communicate grounding	



### 3.2.6.1 Dial Code Switch Function Description

SD90 Signal Switching Dial Code Switch Function Description

Name	Jumpers Figure	Function	Factory default
485 (J4)		RS485 communicational terminal resistance selection ON: 120Ω terminal connection is valid OFF: without terminal connection	OFF
AI1 (J3)		I is for current input (0~20mA) V is for voltage input (0~10V)	0~10V
AO (J2)		I is for current output (0~20mA) V is for voltage output (0~10V)	0~10V

### 3.2.6.2 AO, HDI Function Description and Terminal Setting

AO (analog output), HDI (high frequency pulse input) function and terminal cannot be effective at the same time. Through the combination setting of jumper J5 and jumper J9 and the setting of F04.00, users can select the function of AO and HDI respectively.

Jumper Terminal J5	Jumper Terminal J9	F04.00 Setting	Description
 AO1 HDI	 AO2 AO1	F04.00 = 1	Ao function (Terminal) is valid
 AO1 HDI	Invalid	F04.00 = 0	HDI function (Terminal) is valid

### 3.2.6.3 Control Terminal Wiring Description (Analog Input Terminal)

Weak analog voltage signals are easy to suffer external interference. Generally, select shielded cable no longer than 20m, as shown in figure3-7. In applications where the analog signal suffers severe interference, install filter capacitor or ferrite magnetic core at the analog signal source, as shown in figure 3-8.

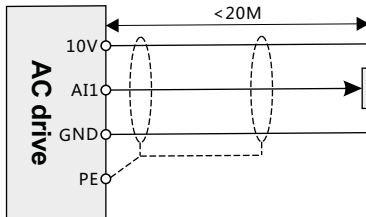

Fig. 3-7 Analog input terminal wiring diagram

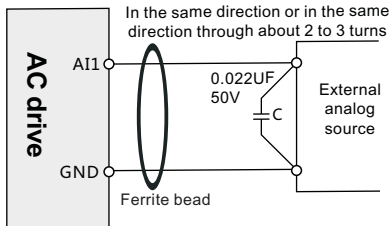
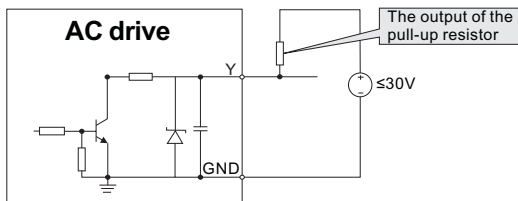

Fig. 3-8 Analog input terminal process wiring diagram



## 3.2.6.4 Digital Output Terminal Instructions



( a ) Output of the pull-up resistor wiring diagram

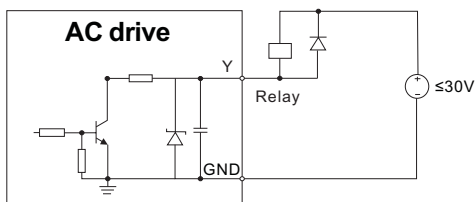

( b ) Output of driving relay wiring diagram

Fig. 3-9 Digital output terminal wiring diagram





# Chapter 4

## Operation, Display and Application Examples

### **This chapter content**

This chapter contains the following operations:

Buttons, indicator lights and the screen as well as the methods to inspect, modify and set function codes by keypad.

## 4.1 Introduction of the keypad

You can modify the parameters, monitor the working status and start or stop the SD90 by operating the operation panel, as shown in the following figure.











Fig 4-1 Keypad

### Note:

It is necessary to use M3 screw or install bracket to fix the external keypad.

No	Name	Instructions		
①	Status indicator	RUN	LED off means that the AC drive is in the stop state; LED on means the AC drive is in the running state.	
		LOCAL/REMOT	It indicates whether the AC drive is operated by means of operation panel, terminals or communication.	
			○ LOCAL/REMOT: OFF	Operation panel control
			● LOCAL/REMOT: ON	Terminals control
● LOCAL/REMOT: Blinking	Communication control			
	FWD/REV	ON means the AC drive is in the reverse rotation state; OFF means the AC drive is in the forward rotation state.		
②	Unit indicator	It represents the current display of the keypad		
		Hz	Frequency unit	
		A	Current unit	

No	Name	Instructions					
3	Digital potentiometer	When the frequency source A or B is set to 1, the setting of the frequency source is determined by analog potentiometer input voltage. The maximum output voltage corresponding to the maximum frequency. The minimum voltage corresponding to 0Hz					
4	Code display zone	Five-figure LED display displays various monitoring data and alarm code such as set frequency and output frequency.					
		Display letter	Corresponding letter	Display letter	Corresponding letter	Display letter	Corresponding letter
		0	0	1	1	2	2
		3	3	4	4	5	5
		6	6	7	7	8	8
		9	9	A	A	b	B
		C	C	d	d	E	E
		F	F	H	H	I	I
		L	L	N	N	n	n
		o	o	P	P	r	r
		S	S	t	t	U	U
		v	v	.	.	-	-
5	Keypad buttons zone		Program key	Enter or exit Level I menu.			
			Confirm key	Enter the menu interfaces level by level, and confirm the parameter setting			
			Increment	Increase data or function code progressively			
			Decrement	Decrease data or function code progressively			
			Right-Shift key	Move right to select the displaying parameter circularly in stopping and running mode. Select the parameter modifying digit during the parameter modification.			
			Run key	The key used to operate the AC drive in keypad operation mode.			
			Stop/Reset key	This key is used to stop in running status and it's limited by function code F06.03. This key used to reset all control modes in the fault alarm state.			
			S key	The function of this key is confirmed by function code F06.01			

## 4.2 Viewing and Modifying Function Codes

The operation panel of SD90 inverter adopts three-level menu.

The three-level menu consists of function code group (Level I), function code (Level II), and function code setting value (level III), as shown in the following figure. Figure 4-2 Operation procedure on the operation panel.

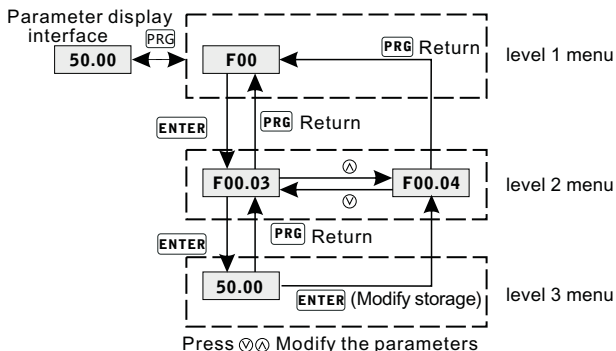

Fig.4-2 Operation Procedure of three-level Menu

### Remarks:

You can return to Level II menu from Level III menu by pressing PRG or ENTER. After you press ENTER, the system saves the parameter setting first, and then goes back to Level II menu and shifts to the next function code. After you press PRG, the system does not save the parameter setting, but directly returns to Level II menu and remains at the current function code.

Here is an example of changing the value of F3-03 to 15.00 Hz:

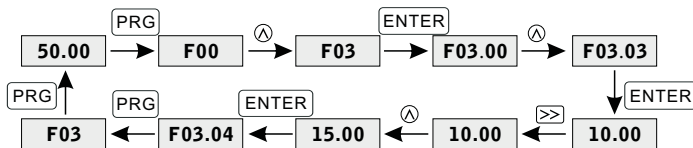

Fig. 4-3 Example of changing the parameter value

In Level III menu, if the parameter has no blinking digit, it means that the parameter cannot be modified. This may be because:

- ① Such a function code is only readable, such as, AC drive model, actually detected parameter and running record parameter.
- ② Such a function code cannot be modified in the running state and can only be changed at stop.

### 4.3 Structure of Function Codes

Function Code Group of Sd90 AC drives

Function Code Group	Function	Instructions
F00~F0C	Setting function codes	Users can set function parameters
F0D	Status function group	Users can view the state parameters
F0F	Factory parameter group	Only factory use

In the function code display state, select the required function group by pressing the key “△” and “▽”, as shown in the following figure.

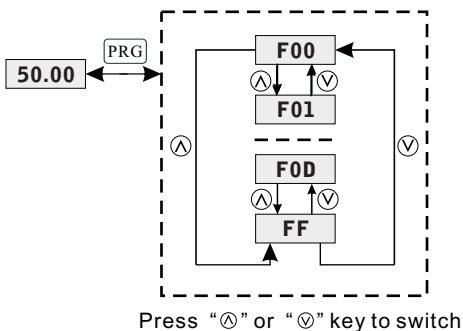

### 4.4 Viewing Status Parameters

Status parameters including stop status parameters and running status parameters which display different contents. In the stop or running state, you can press shift key to display multiple status parameters. Whether parameters are displayed is determined by the binary bits of values converted from the values of F06.04, F06.05 and F06.06 in the hexadecimal format. In stop state, a total of 16 status parameters can be displayed, as listed in the following table.

F06.06	Parameters displayed in stop state	0x0000~0x07FF Bit0: Set frequency (Hz flash slowly ) Bit1: Bus voltage Bit2: Input terminal status Bit3: Output terminal status Bit4: PID setting value Bit5: PID feedback value Bit6: Analog AI1 value Bit7: High-speed pulse HDI frequency Bit8: Multi-speed PLC current segments Bit9: Pulse count value Bit10: Length value Bit11~Bit15: Reserve	0x0FF	○
--------	------------------------------------	--	-------	---

Select required parameter by pressing , Set the values of the parameters by referring to the following examples.

4

Determine the parameters to be displayed. Set frequency, bus voltage, analog AI1 value, pulse count value. The Actual displayed data corresponding to bit setting.

**Binary data F06.06: 0000 0010 0100 0011B**

**Convert to hexadecimal data: 243H**

**So parameter F06.06 is set as 243**

In the running state, the five running parameters of running frequency, set frequency, bus voltage, output voltage, output current are displayed by default. You can set whether other parameters are displayed by setting F06.04 and F06.05, as listed in the following table.



F06.04	Parameters of running status display selection 1	0x0000~0xFFFF Bit0: Running frequency (Hz is ON) Bit1: Set frequency (Hz is flash slowly) Bit2: Bus voltage Bit3: Output voltage Bit4: Output current (A is ON) Bit5: Running rotational speed Bit6: Output power Bit7: Output torque Bit8: PID setting value Bit9: PID feedback value Bit10: Input terminal status Bit11: Output terminal status Bit12: Pulse count value Bit13: Length value Bit14: Multi-stage current segments Bit15: Analog Ai1 value	0x03FF	○
F06.05	Parameters of running status display selection 2	0x0000~0x001F Bit0: High-speed pulse HID frequency Bit1: Motor overload percentage Bit2: AC drive overload percentage Bit3: Ramp frequency setting value (Hz is ON) Bit4: Line speed Bit5-15: Reserve	0x0000	

When the AC drive is powered on again after power failure, the parameters that are selected before power failure are displayed.

Select required parameter by pressing Determine the parameters to be displayed. Running frequency, bus voltage, output voltage, output current, output power, output torque, analog Ai1 value and AC drive overload percentage.

The actual displayed data corresponding to the bit setting.

Binary data:

**F06-04 is 0000 0000 1101 1101B**

**F06-05 is 0000 0000 0000 0100B**

Convert to hexadecimal data:

**F06-04 is 80DDH**

**F06-05 is 0040H**

Keypad setting display value:

**F06-04 is 80 DD**

**F06-05 is 0040**

So parameter F06.04 is set as 80DD, F06.05 is set as 0040.





# Chapter 5

## Function Parameter Table

---

### **This chapter content**

This chapter lists and describes the function parameter codes.

## Function Parameter Table

The function parameters of SD90 series AC drive have been divided into 14 groups (F00 ~ F0D) according to the function.

Each function group contains certain function codes applying 3-level menus. For example, "F08.08" means the eighth function code in the F8 group function. For the convenience of function codes setting, the function group number corresponds to the first level menu, the function code corresponds to the level 2 menu and the function code corresponds to the level 3 menu.

### 1. Below is the instruction of the function lists:

The first line "Function code": codes of function parameter group and parameters;

The second line "Name": full name of function parameters;

The third line "Setting range": effective setting value of the function parameters;

The fourth line "Default value": the original factory values of the function parameter;

The fifth line "Modify": the modifying character of function codes (the parameters can be modified or not and the modifying conditions), below is the instruction:

"○" : means the set value of the parameter can be modified on stop and running state;

"⊙" : means the set value of the parameter can not be modified on the running state;

"●" : means the value of the parameter is the real detection value which can not be modified.

2. "Parameter radix" is decimal (DEC), if the parameter is expressed by hex, then the parameter is separated from each other when editing. The setting range of the certain bits are 0-F (hex).

3. "Default" means the function code parameters will restore to the default value during default parameters restoring. But the actually detected parameter value or record value won't be restored.

4. For a better parameter protection, the AC drive provides password protection to the function code. After setting user's password (set F006.00 to any non-zero number), the system will enter the state of password verification firstly after the user press PRG key to come into the function code editing state. And then "00000" will be displayed. Unless the users input right password, they can not enter into the system. For the factory setting parameter zone, it needs correct password to enter the system (remind that the users can not modify the factory parameters by themselves, if the parameter setting incorrect, it will result in abnormal operation even damage to the inverter.

If the password protection is unlocked, the user can modify the password freely and the AC drive will work as the last setting one. When F06.00 is set to 0, the password can be canceled. If F06.00 is not 0 during powering on, then the parameter is protected by the password. When modify the parameters by serial communication the function of the password follows the above rules, too.

Function Code	Name	Setting Range	Default	Property
Group F00 Basic Function				
F00.00	Speed control mode	0: V/F control 1: Vector mode 0 control	1	⊙
F00.01	Run command channel	0: Keypad running command channel (LED OFF) 1: Terminal running command channel (LED ON) 2: MODBUS communication running command channel (LED FLASH)	0	○
F00.02	Reserve	0	0	●
F00.03	Maximum output frequency	F00.04~600.00 Hz	50 Hz	⊙
F00.04	Upper limit of the running frequency	F00.05~F00.03 (Max. frequency)	50 Hz	⊙
F00.05	Lower limit of the running frequency	0.00Hz~F00.04 (Upper limit)	0.0 Hz	⊙
F00.06	A frequency command selection	0: Keypad digital setting 1: Panel potentiometer setting 2: Analog AI1 setting 3: Reserve 4: High-pulse setting(HDI) 5: Simple PLC program setting 6: Multi-stage speed running setting 7: PID control setting 8: MODBUS communication setting	1	○
F00.07	B frequency command selection	0: Keypad digital setting 1: Panel potentiometer setting 2: Analog AI1 setting 3: Reserve 4: High-pulse setting(HDI) 5: Simple PLC program setting 6: Multi-stage running setting 7: PID control setting 8: MODBUS communication setting	5	○
F00.08	B frequency command reference	0: Max output frequency 1: A frequency command	0	⊙
F00.09	B frequency source gain coefficient	0.0~100.0%	100.0%	○

Function Code	Name	Setting Range	Default	Property
F00.10	Combination mode of the setting	0: A 1: B 2: (A+B) 3: (A-B) 4: Max. (A, B) 5: Min. (A, B)	0	○
F00.11	Keypad set frequency	0.00 Hz~F00.03 (max. frequency )	50.00Hz	○
F00.12	Acceleration time 1	0.0~3600.0s	Model dependent	○
F00.13	Deceleration time 1	0.0~3600.0s	Model dependent	○
F00.14	Running direction	0: Default direction 1: Reverse direction 2: Prohibit reverse running	0	○
F00.15	High frequency carrier setting	2.0kHz~10.0kHz	Model dependent	○
F00.16	Low frequency carrier setting	2.0kHz~F00.15	Model dependent	○
F00.17	Motor parameter auto-tuning	0: None 1: Stator resistance + No-load current auto-tuning 2: No-load current auto-tuning 3: Stator resistance auto-tuning	0	⊙
F00.18	Function restore parameter	0: No operation 1: Restore default value 2: Cancel the fault record	0	⊙
<b>Group F01 Start-up and Stop Control</b>				
F01.00	Start running mode	0: Start-up directly 1: Start-up after DC braking	0	⊙
F01.01	Starting frequency of direct start	0.00~50.00Hz	0.50Hz	⊙
F01.02	Retention time of the starting frequency	0.0~100.0s	0.0s	⊙
F01.03	Braking current before starting	0.0~150.0%	0.0%	⊙
F01.04	Braking time before starting	0.0~120.0s	0.0s	⊙

Function Code	Name	Setting Range	Default	Property
F01.05	ACC and DEC mode selection	0: Line 1: Reserve	0	⊙
F01.06	Stop mode selection	0: Decelerate to stop 1: Coast to stop	0	○
F01.07	Starting frequency of stop braking	0.00~F00.03 (Max. frequency )	0.00Hz	○
F01.08	Waiting time of stop braking	0.0~50.0s	0.0s	○
F01.09	Stop DC braking current	0.0~150.0%	0.0%	○
F01.10	Stop DC braking time	0.0~120.0s	0.0s	○
F01.11	Dead time of FWD/REV rotation	0.0~3600.0s	0.0s	○
F01.12	Shift mode of FWD/REV rotation	0: Shift after zero frequency 1: Shift after starting frequency 2: Shift after stopping speed and delay time (delay time is set by F01.22)	0	⊙
F01.13	Stopping frequency	0.00~50.00Hz	1.00Hz	⊙
F01.14	Detection time of stop frequency	0.0~100.0s	0.5s	⊙
F01.15	Reserve	0	0	●
F01.16	Terminal running protection selection when powering on	0: The terminal running command is invalid when powering on 1: The terminal running command is valid when powering on	0	○
F01.17	Action if running frequency < frequency lower limit (Valid: > 0)	0: Run at lower limit frequency 1: Stop 2: Zero speed operation	0	⊙
F01.18	Hibernation restore delay Time	0.0~3600.0s (F01.17 = 2 is valid)	0.0s	○
F01.19	Restart after power off	0: Disable 1: Enable	0	○
F01.20	Waiting time of restart after power off	0.0~3600.0s (F01.19=1 is valid)	1.0s	○



Function Code	Name	Setting Range	Default	Property
F01.21	Start delay time	0.0 ~ 60.0s	0.0s	○
F01.22	Delay time of the stop speed	0.0~100.0s	0.0s	○
Group F02 Motor Parameters				
F02.00	Reserve	0	0	●
F02.01	Motor type	0: General asynchronous motor (With low frequency compensation) 1: AC drive asynchronous motor (without low frequency compensation)	0	◎
F02.02	Motor rated power	0.1~100.0kW	Model dependent	◎
F02.03	Motor rated voltage	0~1200V	Model dependent	◎
F02.04	Motor rated current	0.8~1000.0A	Model dependent	◎
F02.05	Motor rated frequency	0.01Hz~F00.03 (max frequency)	50.00Hz	◎
F02.06	Motor rated rotational speed	1~36000rpm	Model dependent	◎
F02.07	Motor stator resistance	0.001~65.535Ω	Model dependent	○
F02.08	Motor no-load current	0.2~300.0A	Model dependent	○
F02.09	Overload protection selection	0: No protection 1: General Motor protection 2: Variable frequency motor protection	1	◎
F02.10	Overload protection coefficient	20.0%~120.0%	100.0%	○
Group F03 V/F Control				
F03.00	V/F curve setting	0: Linear V/F curve 1: Multiple-point V/F curve 2: 1.3 <sup>th</sup> power low torque V/F curve 3: 1.7 <sup>th</sup> power low torque V/F curve 4: 2.0 <sup>th</sup> power low torque V/F curve	0	◎
F03.01	Torque boost	0.0% (Automatic) 0.1%~20.0%	0.0%	○
F03.02	Torque boost close	0.0~50.0% (Relative to motor rated frequency)	20.0%	○
F03.03	V/F frequency point 1	0.00Hz~F03.05	00.00Hz	○

Function Code	Name	Setting Range	Default	Property
F03.04	V/F voltage point1	0.0~100.0% (Motor rated voltage)	00.0%	○
F03.05	V/F frequency point 2	F03.03~F03.07	00.00Hz	○
F03.06	V/F voltage point 2	0.0~100.0% (Motor rated voltage)	00.0%	○
F03.07	V/F frequency point 3	F03.05~F02.05 (Motor rated frequency)	00.00Hz	○
F03.08	V/F voltage point 3	0.0~100.0% (Motor rated voltage)	00.0%	○
F03.09	V / F slip compensation gain	0.0~200.0%	100.0%	○
F03.10	V / F slip compensation close frequency	0.00HZ~F00.03 (max frequency)	50.00Hz	○
F03.11	Low frequency suppression oscillation factor	0~30	2	○
F03.12	High frequency suppression oscillation factor	0~30	2	○
F03.13	Motor suppression oscillation demarcation point	0.00Hz~F00.03 (Max frequency)	30.00Hz	○
F03.14	Reserved	-----	-	-
F03.15	Reserved	-----	-	-
F03.16	Reserved	-----	-	-
F03.17	Reserved	-----	-	-
F03.18	Reserved	-----	-	-
F03.19	Reserved	-----	-	-
F03.20	AVR function selection	0: Invalid 1: Valid	1	○

Function Code	Name	Setting Range	Default	Property
Group F04 Input Terminals				
F04.00	HDI input/AO output function selection	0: HDI input enabled (See F04.23~F04.28) 1: AO output enabled (See F04.21)  Note: This function parameter setting affects the function of the effectiveness of the control board HDI terminal and AO terminals. Users also need to control board J5, J9 jumper to configure options.	0	⊙
F04.01	S1 terminal function selection	0: No function 1: Forward rotation operation 2: Reverse rotation operation 3: 3-line running control 4: Forward jogging 5: Reverse jogging 6: Coast to stop 7: Fault reset	1	⊙
F04.02	S2 terminal function selection	8: Operation pause 9: External fault input 10: Increasing frequency setting (UP) 11: Decreasing frequency setting (DOWN) 12: Frequency increase or decrease setting clear 13: Shift between A setting and B setting	4	⊙
F04.03	S3 terminal function selection	14: Shift between combination setting and A setting 15: Shift between combination setting and B setting 16: Multi-stage speed terminal 1 17: Multi-stage speed terminal 2 18: Multi-stage speed terminal 3 19: Multi-stage speed terminal 4	7	⊙
F04.04	S4 terminal function selection	20: Multi-stage speed pause 21: ACC/DEC time selection 1 22: ACC/DEC time selection 2 23: Reserve 24: Reserve 25: PID control pause	0	⊙

(Continued)

Function Code	Name	Setting Range	Default	Property
F04.05	S5 terminal function selection	26: Reserve 27: Reserve 28: Counter reset 29: Reserve 30: ACC/DEC prohibited 31: Reserve 32: Reserve 33: Frequency setting clear	0	⊙
F04.06	Reserve	34: DC braking 35: Reserve 36: Shift the command to the keypad 37: Shift the command to the terminal 38: Shift the command to the communication 39: PID parameter switchover	0	●
F04.07	Polarity selection of input terminals Bit4 Bit3 Bit2 Bit1 Bit0 S5 S4 S3 S2 S1	0x000~0x01F	0x000	○
F04.08	ON-OFF filter time	0.000~1.000s	0.010s	○
F04.09	Virtual terminal setting	0: Virtual terminal is invalid 1: MODBUS communication virtual terminal is valid	0	⊙
F04.10	Terminals control running modes	0: Two-line control 1 1: Two-line control 2 2: Three-line control 1 3: Three-line control 2	0	⊙
F04.11	Switch-on delay of S1 terminal	0.000~50.000s	0.000s	○
F04.12	Switch-off delay of S1 terminal	0.000~50.000s	0.000s	○
F04.13	Switch-on delay of S2 terminal	0.000~50.000s	0.000s	○
F04.14	Switch-off delay of S2 terminal	0.000~50.000s	0.000s	○
F04.15	Switch-on delay of S3 terminal	0.000~50.000s	0.000s	○

Function Code	Name	Setting Range	Default	Property
F04.16	Switch-off delay of S3 terminal	0.000~50.000s	0.000s	○
F04.17	Switch-on delay of S4 terminal	0.000~50.000s	0.000s	○
F04.18	Switch-off delay of S4 terminal	0.000~50.000s	0.000s	○
F04.19	Switch-on delay of S5 terminal	0.000~50.000s	0.000s	○
F04.20	Switch-off delay of S5 terminal	0.000~50.000s	0.000s	○
F04.21	Reserve	0	0	●
F04.22	Reserve	0	0	●
F04.23	HDI high-speed pulse input function selection	0: Frequency setting input 1: Counter input (reserve) 2: length count value input	0	⊙
F04.24	Lower limit frequency of HDI	0.00kHz~F04.26	0.00kHz	○
F04.25	Corresponding setting of lower limit frequency of HDI	-100.0~100.0%	0.0%	○
F04.26	Upper limit frequency of HDI	F04.24 ~50.00kHz	50.00kHz	○
F04.27	Corresponding setting of upper limit frequency of HDI	-100.0~100.0%	100.0%	○
F04.28	HDI frequency input filter time	0.000~10.000s	0.100s	○
F04.29	Lower limit value of AI1	0.00V~F04.31	0.00V	○
F04.30	Corresponding setting of lower limit of AI1	-100.0~100.0%	0.0%	○
F04.31	AI1 upper limit value	F04.29~10.00V	10.00V	○
F04.32	Corresponding setting of upper limit of AI1	-100.0~100.0%	100.0%	○

Function Code	Name	Setting Range	Default	Property
F04.33	All input filter time	0.000~10.000s	0.100s	○
F04.34	Keypad analog filter time	0.000~10.000s	0.050s	○
Group F05 Output Terminals				
F05.00	Reserve	0	0	●
F05.01	Y output selection	0: Invalid 1: Running 2: Forward running 3: Reverse running 4: Jog running 5: AC drive fault 6: Frequency level detection FDT1 7: Frequency level detection FDT2 8: Frequency reached 9: Zero-speed running 10: Upper limit frequency reached 11: Lower limit frequency reached 12: Ready for running 13: Reserve 14: Overload pre-warning 15: Reserve 16: Completion of simple PLC stage 17: Completion of simple PLC cycle 18: Setup count value arrival 19: Designated count value reached 20: External fault is valid 21: Length reached 22: Running time reached 23: MODBUS communication virtual terminal output 24: Torque arrival	1	○
F05.02	Reserve		0	●
F05.03	Relay RO output selection		1	○
F05.04	Reserve		0	●
F05.05	Polarity of output terminals Bit3 Bit2 Bit1 Bit0 0 0 R0 Y	0x0~0x3	0x0	○
F05.06	Y switch-on delay time	0.000~50.000s	0.000s	○
F05.07	Y switch-off delay time	0.000~50.000s	0.000s	○
F05.08	Relay RO switch-on delay time	0.000~50.000s	0.000s	○

Function Code	Name	Setting Range	Default	Property
F05.09	Relay RO switch-off delay time	0.000~50.000s	0.000s	○
F05.10	AO output selection	0: Running frequency 1: Set frequency 2: Ramp reference frequency 3: Running speed 4: Output current (relative to AC drive rated current) 5: Output current (relative to motor rated current) 6: Output voltage 7: Output power 8: Reserve 9: Output torque 10: Analog AI1 input value 11: Reserve 12: Reserve 13: High-speed pulse HDI input value 14: MODBUS communication setting value	0	○
F05.11	Lower output limit of AO	0.0%~F05.13	0.0%	○
F05.12	Corresponding AO output of lower limit	0.00~10.00V	0.00V	○
F05.13	Upper output limit of AO	F05.11~100.0%	100.0%	○
F05.14	Corresponding AO output of upper limit	0.00~10.00V	10.00V	○
F05.15	Ao output filter time	0.000~10.000s	0.000s	○
Group F06 HMI Group				
F06.00	User's password	0~65535	0	○
F06.01	S key function selection	0: No function 1: Jog running 2: Shift the display state by the shifting key 3: Shift between forward rotations and reverse 4: Clear UP/DOWN settings 5: Coast to stop 6: Command source switch	1	⊙

Function Code	Name	Setting Range	Default	Property
F06.02	Reserved	-----	-	-
F06.03	STOP/RESET stop function selection	0: Only valid for keypad control 1: Both valid for keypad and terminal control 2: Both valid for keypad and communication control 3: Valid for all control modes	0	○
F06.04	Parameters state 1	0x0000~0xFFFF Bit0: Running frequency (Hz ON) Bit1: Set frequency (Hz blinking) Bit2: Bus voltage Bit3: Output voltage Bit4: Output current (A ON) Bit5: Running speed Bit6: Output power Bit7: Output torque Bit8: PID reference value Bit9: PID feedback value Bit10: Input terminal state Bit11: Output terminal state Bit12: Pulse count value Bit13: Length value Bit14: The current stage in Multi-stage speed Bit15: Analog AI1 value	0x03FF	○
F06.05	Parameters state 2	0x00~0x1F Bit0: High-speed pulse HDI frequency Bit1: Motor overload percentage Bit2: AC drive overload percentage Bit3: Ramp frequency setting value (Hz is ON) Bit4: Linear speed Bit5~15: Reserve	0x00	○



Function Code	Name	Setting Range	Default	Property
F06.06	Parameters for stopping state	0x000~0x7FF Bit0: Set frequency (Hz is flicking slowly) Bit1: Bus voltage Bit2: Input terminal state Bit3: Output terminal state Bit4: PID reference value Bit5: PID feedback value Bit6: Analog AI1 value Bit7: High-speed pulse HDI frequency Bit8: The current stage in Multi-stage speed Bit9: Pulse count value Bit10: Length value Bit11~Bit15: Reserve	0x0FF	○
F06.07	Frequency display coefficient	0.01~20.00 Displayed frequency = running frequency × F06.07	1.00	○
F06.08	Rotation speed display coefficient	0.1~999.9% Mechanical rotation speed = 60 × running frequency × F06.08 / Motor pole pairs	100.0%	○
F06.09	Linear speed display coefficient	0.1~999.9% Linear speed = Mechanical rotation speed × F06.09	1.0%	○
F06.10	Reserve	0	0	●
F06.11	Converter module temperature	-20.0~120.0°C	-	●
F06.12	Control board software version	1.00~655.35	-	●
F06.13	Cumulative running time of the unit	0~65535h	0	○
F06.14	Reserve	0	0	●
F06.15	AC drive rated power	0.4~100.0kW	-	●
F06.16	AC drive rated voltage	50~1000V	-	●
F06.17	AC drive rated current	0.1~1000.0A	-	●

Function Code	Name	Setting Range	Default	Property
F06.18	Current fault type	See chapter 7.7	-	●
F06.19	Previous 1 fault type		-	●
F06.20	Previous 2 fault type		-	●
F06.21	Running frequency at current fault	---	0.00Hz	●
F06.22	Ramp reference frequency at current fault	---	0.00Hz	●
F06.23	Output voltage at current fault	---	0V	●
F06.24	Output current at current fault	---	0.0A	●
F06.25	Bus voltage at current fault	---	0.0V	●
F06.26	The Max. temperature at current fault	---	0.0°C	●
F06.27	Input terminals state at current fault	---	0	●
F06.28	Output terminals state at current fault	---	0	●
F06.29	Running frequency at previous fault	---	0.00Hz	●
F06.30	Ramp reference frequency at previous fault	---	0.00Hz	●
F06.31	Output voltage at previous fault	---	0V	●
F06.32	Output current at previous fault	---	0.0A	●
F06.33	Bus voltage at previous fault	---	0.0V	●
F06.34	The Max. temperature at previous fault	---	0.0°C	●

Function Code	Name	Setting Range	Default	Property
F06.35	Input terminals state at previous fault	---	0	●
F06.36	Output terminals state at previous fault	---	0	●
Group F07 Enhanced Group				
F07.00	Acceleration time 2	0.0~3600.0s	Model dependent	○
F07.01	Deceleration time 2	0.0~3600.0s	Model dependent	○
F07.02	Acceleration time 3	0.0~3600.0s	Model dependent	○
F07.03	Acceleration time 3	0.0~3600.0s	Model dependent	○
F07.04	Deceleration time 4	0.0~3600.0s	Model dependent	○
F07.05	Acceleration time 4	0.0~3600.0s	Model dependent	○
F07.06	Jogging frequency	0.00~F00.03 (Max. frequency )	5.00Hz	○
F07.07	Jogging ACC time	0.0~3600.0s	Model dependent	○
F07.08	Jogging DEC time	0.0~3600.0s	Model dependent	○
F07.09	Fault auto reset times	0~10	0	○
F07.10	Interval time of fault auto reset	0.1~3600.0s	1.0s	○
F07.11	Reserve	0	0	●
F07.12	Reserve	0	0	●
F07.13	FDT1 electrical level detection value	0.00~F00.03 (Max. frequency)	50.00Hz	○
F07.14	FDT1 retention detection value	0.0~100.0% (FDT1 level)	5.0%	○
F07.15	FDT2 electrical level detection value	0.00~F00.03 (Max. frequency)	50.00Hz	○
F07.16	FDT2 retention detection value	0.0~100.0% (FDT2 level)	5.0%	○

Function Code	Name	Setting Range	Default	Property
F07.17	Frequency arrival detection value	0.0~F00.03 (Max. frequency )	0.00Hz	○
F07.18	Energy braking enable	0: Energy braking disable 1: Energy braking enable	1	○
F07.19	Threshold voltage of energy braking	200.0~1000.0V	220V level: 380.0V	○
			380V level: 700.0V	
F07.20	Reserve	0	0	●
F07.21	Over commission selection	0: Over commission is invalid 1: Over commission is valid	0	⊙
F07.22	Keypad digital control setting	0x000~0x1221 LED ones: frequency control selection 0: $\wedge$ /v key adjustment is invalid 1: $\wedge$ /v key adjustment is valid LED tens: frequency control 0: Only valid for F00.06=0 or F00.07=0 setting 1: Valid for all frequency modes 2: Invalid for MS when MS is priority LED hundreds: stop action selection 0: Setting is valid 1: Valid during running, cleared after stopping 2: Valid during running, cleared after receiving the stop command LED thousands: $\wedge$ /v key integral function 0: Integral function is valid 1: Integral function is invalid	0x0001	○
F07.23	Integral ratio of the keypad $\wedge$ /v	0.01~10.00s	0.10s	○
F07.24	UP/DOWN terminal control setting	0x000~0x221 LED ones: frequency control 0: UP/DOWN terminal setting valid 1: UP/DOWN terminal setting invalid LED tens: frequency control 0: Only valid for F00.06=0 or F00.07=0 setting 1: Valid for all frequency modes 2: Invalid for multi-sted when multi-sted is priority LED hundreds: Action selection when stop 0: Setting is valid	0x000	○

Function Code	Name	Setting Range	Default	Property
F07.24	UP/DOWN terminal control setting	1: Valid in running, clear after stop 2: Valid in running, clear after receiving the stop commands	0x000	○
F07.25	Up terminal frequency changing ratio	0.01~50.00s	0.50s	○
F07.26	DOWN terminal frequency changing ratio	0.01~50.00s	0.50s	○
F07.27	Frequency setting at power loss	0x00~0x011 LED ones: Action selection when power off 0: Save when power off 1: Clear when power off LED tens: Action selection when MODBUS set frequency power off 0: Save when power off 1: Clear when power off	0x00	○
F07.28	Magnetic flux braking	0: invalid 1~100: The bigger the coefficient, the stronger the braking is.	0	○
F07.29	PWM modulation mode	0: 3-phase modulation 1: 2/3 -phase modulation switchover	1	⊙
Group F08 PID Control				
F08.00	PID reference source selection	0: Keypad digital reference(F08.01) 1: Analog channel AI1 reference 2: Reserve 3: High-speed pulse HDI setting 4: MS reference 5: MODBUS communication setting	0	○
F08.01	Keypad preset PID reference	-100.0~100.0%	50.0%	○
F08.02	PID feedback source selection	0: Analog channel AI1 feedback 1: Reserve 2: High-speed pulse HDI feedback 3: MODBUS communication feedback	0	○
F08.03	PID output feature selection	0: PID output is positive 1: PID output is negative	0	○
F08.04	Proportional gain (Kp 1)	0.00~100.00	0.50	○

Function Code	Name	Setting Range	Default	Property
F08.05	Integral time1 (Ti 1)	0.00~10.00s	0.20s	○
F08.06	Differential time 1 (Td 1)	0.00~10.00s	0.00s	○
F08.07	Sampling cycle (T)	0.01~10.00s	0.10s	○
F08.08	PID control deviation limit	0.0~100.0%	0.0%	○
F08.09	Output upper limit of PID	F08.10~100.0% (Max. frequency or voltage )	100.0%	○
F08.10	Output lower limit of PID	-100.0%~F08.09	0.0%	○
F08.11	Detection value of feedback offline	0.0~100.0%	0.0%	○
F08.12	Detection time of feedback offline	0.0~3600.0s	1.0s	○
F08.13	PID adjustment selection	0x00~0x11 LED ones 0: Keep on integral adjustment when the frequency achieves the upper and lower limit. 1: Stop integral adjustment when the frequency achieves the upper and lower limit LED tens 0: The same with the setting direction 1: Opposite to the setting direction	0x00	○
F08.14	Proportional gain 2 (Kp2)	0.00~100.00	0.50	○
F08.15	Integral time 2 (Ti2)	0.00~10.00s	0.20s	○
F08.16	Differential time 2 (Td2)	0.00~10.00s	0.00s	○
F08.17	Switchover selection of PID	0: Without switchover 1: Switch according to the input deviation 2: Switch according to terminal.	0	⊙

Function Code	Name	Setting Range	Default	Property
F08.18	Input deviation threshold when PID switching	0.0~100.00%	20%	○
F08.19	PID initial value	-100.0%~100.0%	0.0%	○
F08.20	PID initial holding time	0.0~600.0s	0.0s	○
Group F09 Swing Frequency, Fixed-length,Count and Fixed Time Parameters				
F09.00	Reserve	0	0	●
F09.01	Reserve	0	0	●
F09.02	Reserve	0	0	●
F09.03	Reserve	0	0	●
F09.04	Set length	0~65535m	0m	○
F09.05	Actual length	0~65535m	0m	●
F09.06	Pulse per rotation	1~10000	1	○
F09.07	Alxe perimeter	0.01~100.00cm	10.00cm	○
F09.08	Length ratio	0.001~10.000	1.000	○
F09.09	Length correcting coefficient	0.001~1.000	1.000	○
F09.10	Set count value	F09.11~65535	0	○
F09.11	Designated count value	0~F09.10	0	○
F09.12	Running time setting	0~65535min	0	○
F09.13	Exact stop mode	0: Stop invalid 1: Setting length reached 2: Setting counter value reached	0	○
F09.14	Torque arrive setting value	0.0 ~ 250.0%	100.0	○
Group F0A Simple PLC and Multi- step Speed Control				
F0A.00	Simple PLC mode	0: Stop after running once 1: Run at the final value after running once 2: Cycle running	0	○
F0A.01	Simple PLC retentive selection	0: No retentive upon power failure 1: Retentive upon power failure	0	○
F0A.02	Multi-stage speed 0	-100.0~100.0%	0.0%	○

Function Code	Name	Setting Range	Default	Property
F0A.03	The running time of step 0	0.0~6553.5s(min)	0.0s	○
F0A.04	Multi-stage speed 1	-100.0~100.0%	0.0%	○
F0A.05	The running time of step 1	0.0~6553.5s(min)	0.0s	○
F0A.06	Multi-stage speed 2	-100.0~100.0%	0.0%	○
F0A.07	The running time of step 2	0.0~6553.5s(min)	0.0s	○
F0A.08	Multi-stage speed 3	-100.0~100.0%	0.0%	○
F0A.09	The running time of step 3	0.0~6553.5s(min)	0.0s	○
F0A.10	Multi-stage speed 4	-100.0~100.0%	0.0%	○
F0A.11	The running time of step 4	0.0~6553.5s(min)	0.0s	○
F0A.12	Multi-stage speed 5	-100.0~100.0%	0.0%	○
F0A.13	The running time of step 5	0.0~6553.5s(min)	0.0s	○
F0A.14	Multi-stage speed 6	-100.0~100.0%	0.0%	○
F0A.15	The running time of step 6	0.0~6553.5s(min)	0.0s	○
F0A.16	Multi-stage speed 7	-100.0~100.0%	0.0%	○
F0A.17	The running time of step 7	0.0~6553.5s(min)	0.0s	○
F0A.18	Multi-stage speed 8	-100.0~100.0%	0.0%	○
F0A.19	The running time of step 8	0.0~6553.5s(min)	0.0s	○
F0A.20	Multi-stage speed 9	-100.0~100.0%	0.0%	○
F0A.21	The running time of step 9	0.0~6553.5s(min)	0.0s	○
F0A.22	Multi-stage speed10	-100.0~100.0%	0.0%	○
F0A.23	The running time of step 10	0.0~6553.5s(min)	0.0s	○



Function Code	Name	Setting Range	Default	Property
F0A.24	Multi-stage speed11	-100.0~100.0%	0.0%	○
F0A.25	The running time of step 11	0.0~6553.5s(min)	0.0s	○
F0A.26	Multi-stage speed12	-100.0~100.0%	0.0%	○
F0A.27	The running time of step 12	0.0~6553.5s(min)	0.0s	○
F0A.28	Multi-stage speed13	-100.0~100.0%	0.0%	○
F0A.29	The running time of step 13	0.0~6553.5s(min)	0.0s	○
F0A.30	Multi-stage speed14	-100.0~100.0%	0.0%	○
F0A.31	The running time of step 14	0.0~6553.5s(min)	0.0s	○
F0A.32	Multi-stage speed15	-100.0~100.0%	0.0%	○
F0A.33	The running time of step 15	0.0~6553.5s(min)	0.0s	○
F0A.34	Simple PLC 0~7 step ACC/DEC time	0x000~0xFFFF	0x0000	○
F0A.35	Simple PLC 8~15 step ACC/DEC time	0x000~0xFFFF	0x0000	○
F0A.36	PLC restart mode selection	0: Restart from the first step. 1: Continue to run from the stop frequency.	0	⊙
F0A.37	Multi-stage time unit	0: seconds 1: minutes	0	⊙
Group F0B Protective Parameters				
F0B.00	Output phase loss protection	0: Invalid 1: Valid	1	⊙
F0B.01	Frequency decrea- sing at sudden power loss	0: Invalid 1: Valid	0	⊙
F0B.02	Frequency decrea- sing ratio at sudden power loss	0.00Hz/s~F00.03/ (Max. frequency)	10.00Hz/s	⊙
F0B.03	Over-voltage stall protection	0: Invalid 1: Valid	1	⊙

Function Code	Name	Setting Range	Default	Property
F0B.04	Voltage protection of over-voltage stall	120~150% (Standard bus voltage 220V)	120%	○
		120~150% (Standard bus voltage 380V)	125%	
F0B.05	Current limit action selection	0: Current-limiting is invalid 1: Current-limiting is valid	1	⊙
F0B.06	Automatic current limit	50.0~200.0%	Model dependent	⊙
F0B.07	Frequency-decreasing ratio during current limit	0.00~50.00Hz/s	10.00Hz/s	⊙
F0B.08	Reserve	0	0	●
F0B.09	Reserve	0	0	●
F0B.10	Reserve	0	0	●
F0B.11	Output terminal action during fault	LED ones 0: Action under fault undervoltage 1: No action under fault undervoltage LED tens 0: Action during the automatic reset 1: No action during the automatic reset	0x00	○
Group F0C Serial Communication Function				
F0C.00	Local communication address	0~247 (0 is the broadcast address)	1	○
F0C.01	Communication baud ratio setting	0: 1200BPS 1: 2400BPS 2: 4800BPS 3: 9600BPS 4: 19200BPS 5: 38400BPS	4	○
F0C.02	Digital bit checkout setting	0: No check (N, 8, 1) for RTU 1: Even check (E, 8, 1) for RTU 2: Odd check (O, 8, 1) for RTU 3: No check (N, 8, 2) for RTU 4: Even check (E, 8, 2) for RTU 5: Odd check (O, 8, 2) for RTU	1	○
F0C.03	Answer delay	0~200ms	5ms	○

Function Code	Name	Setting Range	Default	Property
F0C.04	Fault time of communication overtime	0.0 (invalid), 0.1~60.0s	0.0s	○
F0C.05	Transmission fault processing	0: Alarm and stop freely 1: No alarm and continue to run 2: No alarm and stop according to the stop mode (Only under the communication control) 3: No alarm and stop according to the mode (Under all control modes)	0	○
F0C.06	Communication processing action selection	0: Write with response. 1: Write without response.	0	○
F0C.07	Host broadcast interval time	10ms-5000ms	200ms	○
F0C.08	MODBUS communication mode selection	0: Standard RTU mode 1: Master slave mode 1 (Slave only accepts frequency) 2: Master slave mode 2 (Slave accepts frequency and start-stop command)	0	⊙

Function Code	Name	Setting Range	Default	Property
Group F0D Monitoring Function				
F0D.00	Setting frequency	0.00Hz~F00.03	0.00Hz	●
F0D.01	Output frequency	0.00Hz~F00.03	0.00Hz	●
F0D.02	Ramp reference frequency	0.00Hz~F00.03	0.00Hz	●
F0D.03	Output voltage	0~1200V	0V	●
F0D.04	Output current	0.0~5000.0A	0.0A	●
F0D.05	Motor rotational speed	0~65535rpm	0 rpm	●
F0D.06	Reserve	0	0	●
F0D.07	Reserve	0	0	●
F0D.08	Motor power	-300.0~300.0% (relative to motor rated power )	0.0%	●
F0D.09	Output torque	-250.0~250.0% (relative to motor rated torque )	0.0%	●
F0D.10	Evaluated motor frequency	0.00Hz~F00.03	0.00Hz	●
F0D.11	DC bus voltage	0.0~2000.0V	0V	●
F0D.12	Digital input terminals state	0000~001F	0	●
F0D.13	Digital output terminals state	0~3	0	●
F0D.14	Digital adjustment	0.00Hz~F00.03	0.00Hz	●
F0D.15	Reserve	0	0	●
F0D.16	Linear speed	0~65535	0	●
F0D.17	Length value	0~65535	0	●
F0D.18	Counting	0~65535	0	●
F0D.19	AI1 input voltage	0.00~10.00V	0.00V	●
F0D.20	Reserve	0	0	●
F0D.21	Reserve	0	0	●

Function Code	Name	Setting Range	Default	Property
F0D.22	HDI input frequency	0.00~50.00kHz	0.00kHz	●
F0D.23	PID reference value	-100.0~100.0%	0.0%	●
F0D.24	PID feedback value	-100.0~100.0%	0.0%	●
F0D.25	Power factor of the motor	-1.00~1.00	0.0	●
F0D.26	The running time	0-65535min	-	○
F0D.27	The current step of Multi-stage speed and PLC	0~15	0	●





# Chapter 6

## Parameter Description

---

### **This chapter content**

This chapter lists the total function code table and describes the function codes.

**Group F00 Basic Function Group**

Function Code	Name	Setting Range	Default	Property
F00.00	Speed control mode	0~1	1	⊙

0: V/F Control Mode:

It suitable for the less load demanding occasion, for example, fans and pumps load. It can be used for single one AC drive to drive several motors.

1: Vector mode 0 control:

Low frequency and high torque output, strong load adaptability. It can be used for single one AC drive to drive several motors. Motor parameter auto-tuning will be necessary to obtain accurate parameters.

Function Code	Name	Setting Range	Default	Property
F00.01	Run command channel	0~2	0	○

0: Keypad running command channel (LED OFF)

Carry out the command control by RUN, STOP / RESET on the keypad. Set multi-function key S to FWD / REV shifting function (F06.01 = 3) to change the running direction; press RUN and STOP / RESET simultaneously in running state to make the AC drive coast to stop.

1: Terminal running command channel (LED ON)

Carry out the running command control by the forward rotation, reverse rotation and forward jogging and reverse jogging of the multi-function terminals, the Keypad STOP is valid or not by setting F06.03.

2: Communication run command channel (LED is FLASH )

The running command is controlled by the host computer via communication, the Keypad STOP is valid or not by setting F06.03.

Function Code	Name	Setting Range	Default	Property
F00.02	Reserve	0	0	●

This parameter is reserved.



Function Code	Name	Setting Range	Default	Property
F00.03	Maximum output frequency	F00.04~600.00 Hz	50 Hz	⊙

IT is used to set the maximum output frequency of the AC drive. Users should pay attention to this parameter because it's the foundation of the frequency setting and the speed of acceleration and deceleration.

Function Code	Name	Setting Range	Default	Property
F00.04	Upper limit of the running frequency	F00.05~F00.03 (Max. frequency)	50 Hz	⊙

The upper limit of the running frequency is the upper limit of the output frequency of the AC drive which is lower than equal to the maximum output frequency. The AC drive runs at the upper limit frequency if the set frequency is higher than the upper limit one.

Function Code	Name	Setting Range	Default	Property
F00.05	Lower limit of the running frequency	0.00Hz~F00.04 (Upper limit)	0.0 Hz	⊙

The lower limit of the running frequency is the lower limit of the output frequency of the AC drive. The AC drive runs at the lower limit frequency if the set frequency is The action is determined by F01.17.

Note:

The maximum output frequency ≥ The upper limit frequency ≥ The lower limit frequency.

Function Code	Name	Setting Range	Default	Property
F00.06	A frequency command selection	0~8	1	○
F00.07	B frequency command selection	0~8	5	○

**0: Keypad digital setting**

Modify the value F00.11(set the frequency by keypad UP/DOWN) to modify the frequency by the keypad.

**1: Keypad potentiometer setting**

Set the value of the specified frequency source is set by an analog potentiometer knob on the Keypad, the user operates the potentiometer knob to set and modify the value of the frequency source.

**2: Analog AI1 setting**

Set the frequency by analog input terminals.

**3: Reserve****4: High-speed pulse HDI setting**

The frequency is set by high-speed pulse terminals. SD90 series AC drives provide 1 high speed pulse input as the standard configuration. The pulse frequency range is 0.00~50.00kHz. 100% of the high-speed pulse input setting corresponds to the maximum frequency in forward direction (F00.03) and -100.0% corresponds to the maximum frequency in the reverse direction (F00.03).

**5: Simple PLC program setting**

The AC drive runs at simple PLC program mode when F00.05=5 or F00.07=5. Set F0A group (Simple PLC and Multi-stage control ) to select the running frequency, running direction, acceleration and deceleration time and the keeping time of corresponding stage. See the function description of F0A for detailed information.

**6: Multi-stage running setting**

The AC drive runs at Multi-stage speed mode when F00.06 = 6 or F00.07 = 6. Set F04 to select the current running stage and set F0A to select the current running frequency.

**Note:**

The Multi-stage speed has the priority when F00.06 or F00.07 does not equal to 5 or 6, but the setting stage can only be the 1 ~ 15 stage. The setting stage is 0 ~15 if F00.06 or F00.07 equals to 5 or 6.

**7: PID control setting**

The running mode of the AC drive is process PID control when F00.06=7 or F00.07=7. The running frequency of the AC drive is the value after PID effect.

See P08 for the detailed information of the given source, given value, feedback source of PID.

8: MODBUS communication setting.

The frequency is set by MODBUS communication. See F0C for the detailed information.

Function Code	Name	Setting Range	Default	Property
F00.08	B frequency command reference	0~1	0	⊙

0: Maximum output frequency, 100% of B frequency setting corresponds to the maximum output frequency.

1: A frequency command, 100% of B frequency setting corresponds to A frequency setting. Users can choose this code and F00.10 for the fine tuning of A frequency command.

Function Code	Name	Setting Range	Default	Property
F00.09	B frequency source gain coefficient	0.0~100.0%	100.0%	○

The parameter is the gain coefficient of running result of the B frequency source.  $B \text{ frequency source} = B \text{ frequency source command (percentage)} \times B \text{ frequency command reference object} \times B \text{ frequency source gain coefficient}$ . When the user selects B frequency source as the auxiliary frequency source, by setting the auxiliary frequency source to effect the frequency setting by this parameter.

Function Code	Name	Setting Range	Default	Property
F00.10	Combination mode of the setting	0~5	0	○

0: A, the current frequency setting is A frequency source.

1: B, the current frequency setting is B frequency source.

2: A+B, the current frequency setting is A frequency source + B frequency source.

3: A-B, the current frequency setting is A frequency source - B frequency source.

4: MAX (A+B), the current frequency setting is max. one between A frequency source and B frequency source.

5: MIN (A+B), the current frequency setting is the min. one between A frequency source and B frequency source.

Note:

The combination mode can be shifted by F04 (terminal function).

Function Code	Name	Setting Range	Default	Property
F00.11	Keypad set frequency	0.00 Hz~F00.03 (max. frequency )	50.00Hz	○

When A and B frequency commands are selected as "Keyboard number settings", the value of this function code is the original setting one of the frequency data of the AC drive.

Function Code	Name	Setting Range	Default	Property
F00.12	Acceleration time 1	0.0~3600.0s	Model dependent	○
F00.13	Deceleration time 1	0.0~3600.0s	Model dependent	○

Acceleration time means the time needed if the AC drive speeds up from 0Hz to the maximum one (F00.03).

Deceleration time means the time needed if the AC drive speeds down from the maximum one (F00.03) to 0Hz.

Sd90 series AC drives define four groups of acceleration / deceleration time, which can be selected by F04. The factory default acceleration/deceleration time of the AC drive is the first group.

Function Code	Name	Setting Range	Default	Property
F00.14	Running direction	0~2	0	○

0: Runs at the default direction, the AC drive runs in the forward direction. FWD/ REV indicator is OFF.

1: Runs at the reverse direction, the AC drive runs in the reverse direction. FWD / REV indicator is ON.

Modify the function code to shift the rotation direction of the motor. The effect equals to the shifting the rotation direction by adjusting either two of the motor lines (U, V and W). The motor rotation direction can be changed by S key on the keypad. Refer to parameter F06.01.

2: Forbid to run in reverse direction. It can be used in some special cases if the reverse running is disabled.

Note:

When function parameter restores the default value, the motor's running direction will come back to the factory default state, too. In some cases it should be used with caution after commissioning if the change of rotation direction is disabled.

Function Code	Name	Setting Range	Default	Property
F00.15	High frequency carrier setting	2.0kHz~10.0kHz	Model dependent	○

6

Carrier frequency	Electromagnetic noise	Noise, leakage current	Heating eliminating
2kHz	↑ Big ↓ Small	↑ Big ↓ Small	↑ Big ↓ Small
5kHz			
10kHz			

Model & carrier frequency relational table

Model	The factory default carrier frequency
0.2~11KW	6KHz
15~55KW	4KHz
Above 75KW	2KHz

The advantages of high carrier frequency: ideal current waveform, little current harmonic wave and motor noise.

The disadvantages of high carrier frequency: increasing the switch loss, increasing the AC drive temperature and the impact to the output capacity. The

AC drive needs to derate on high carrier frequency. At the same time, the leakage and electrical magnetic interface will increase.

Applying low carrier frequency is contrary to the above, too low carrier frequency will cause unstable running, torque decreasing and surge.

The manufacturer has set a reasonable carrier frequency. In general, users do not need to change the parameter.

When the frequency used exceeds the default carrier frequency, the AC drive need to derate 10% for each additional 1kHz.

Function Code	Name	Setting Range	Default	Property
F00.16	Low frequency carrier setting	2.0kHz~F00.15	Model dependent	○

Setting the carrier frequency in low frequency running state, when actual running frequency is less than 6 Hz, carrier frequency can be set by F00.16.

Function Code	Name	Setting Range	Default	Property
F00.17	Motor parameter auto-tuning	0~3	0	⊙

0: Null

1: Stator resistance+No-load current auto-tuning

2: No-load current auto-tuning

3: Stator resistance auto-tuning

Function Code	Name	Setting Range	Default	Property
F00.18	Function restore parameter	0~2	0	⊙

0: No operation

1: Restore the default value

2: Cancel the fault record

Note:

The function code will restore to 0 after finishing the operation of the selected function code. Restoring to the default value will cancel the user password, please use this function with caution.

### Group F01 Start-stop Control Group

Function Code	Name	Setting Range	Default	Property
F01.00	Start running mode	0: Start-up directly 1: Start-up after DC braking	0	⊙

0: Start-up directly: start from the starting frequency F01.01.

1: Start-up after DC braking: start the motor from the starting frequency after DC braking (set the parameter F01.03 and F01.04).

Function Code	Name	Setting Range	Default	Property
F01.01	Starting frequency of direct start	0.00~50.00Hz	0.50Hz	⊙

Starting frequency of direct start-up means the original frequency during the AC drive starting. See F01.02 for detailed information.

Function Code	Name	Setting Range	Default	Property
F01.02	Retention time of the starting frequency	0.0~100.0s	0.0s	⊙

Set a proper starting frequency to increase the torque of the AC drive during starting. During the retention time of the starting frequency, the output frequency of the AC drive is the starting frequency. And then, the AC drive will run from the starting frequency to the set frequency. If the set frequency is lower than the starting frequency, the AC drive will stop running and keep in the stand-by state. The starting frequency is not limit in the lower limit frequency.

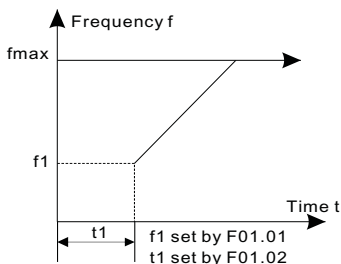

Function Code	Name	Setting Range	Default	Property
F01.03	Braking current before starting	0.0~150.0%	0.0%	⊙
F01.04	Braking time before starting	0.0~120.0s	0.0s	⊙

The AC drive will carry out DC braking with the DC braking current which was set before starting and it will speed up after the DC braking starting time. If the DC braking is set to 0, the DC braking is invalid. The stronger the braking current, the bigger of the braking power. The DC braking current before starting means the percentage of the rated current of the AC drive.

6

Function Code	Name	Setting Range	Default	Property
F01.05	ACC and DEC mode selection	0: Line 1: Reserve	0	⊙

0: Linear type; The output frequency increases or decreases linearly.

1: Reserve

Function Code	Name	Setting Range	Default	Property
F01.06	Stop mode selection	0: Decelerate to stop 1: Coast to stop	0	○

0: Decelerate to stop: after the stop command becomes valid, the AC drive decelerates to decrease the output frequency during the set time. When the frequency decreases to 0Hz, the AC drive stops.



1: Coast to stop: after the stop command becomes invalid, the AC drive ceases the output immediately. And the load coasts to stop at the mechanical inertia.

Function Code	Name	Setting Range	Default	Property
F01.07	Starting frequency of stop braking	0.00~F00.03 (Max. frequency )	0.00Hz	○
F01.08	Waiting time of stop braking	0.0~50.0s	0.0s	○
F01.09	Stop DC braking current	0.0~150.0%	0.0%	○
F01.10	Stop DC braking time	0.0~120.0s	0.0s	○

The starting frequency of stop DC braking: the AC drive will carry on stop DC braking when the frequency is arrived during the procedure of decelerating to stop.

The waiting time of stop braking: before the stop DC braking, the AC drive will close output and begin to carry on the DC braking after the waiting time. This function is used to avoid the over-current fault caused by DC braking when the speed is too high.

Stop DC braking current: the DC brake current added. The stronger the current, the bigger the DC braking effect. Stop DC braking current corresponds to 100% of rated current of the AC drive.

The braking time of stop braking: the retention time of DC brake. If the time is 0s, the DC brake is invalid. The AC drive will stop at the set deceleration time.

Function Code	Name	Setting Range	Default	Property
F01.11	Dead time of FWD/REV rotation	0.0~3600.0s	0.0s	○

During the procedure of switching FWD/REV rotation, set the threshold by F01.13, which is as the table below:

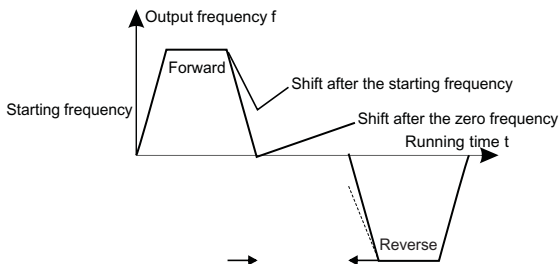

Function Code	Name	Setting Range	Default	Property
F01.12	Shift mode of FWD/REV rotation	0~2	0	⊙

0: Shift after zero frequency

1: Shift after start frequency

2: Shift after the shutdown speed and delay time

Function Code	Name	Setting Range	Default	Property
F01.13	Stopping frequency	0.00~50.00Hz	1.00Hz	⊙

6

F01.13 set the AC drive stop speed threshold. Below this value the AC drive stops running.

Function Code	Name	Setting Range	Default	Property
F01.14	Detection time of stop frequency	0.0~100.0s	0.5s	⊙

When the running frequency of the AC drive is lower than the setting value of F01.13 and the retention time is greater than the setting time of F01.14, the AC drive reaches the stop speed and shutdown.

Function Code	Name	Setting Range	Default	Property
F01.15	Reserve	0	0	●

This parameter is reserved.

Function Code	Name	Setting Range	Default	Property
F01.16	Terminal running protection selection when powering on	0~1	0	○

When the running commands are controlled by the terminal, the system will detect the state of the running terminal during powering on.

0: the terminal running command is invalid when powering on. Even the running command is detected to be valid during powering on, the AC drive will not run and the system keeps in the protection status until the running command is canceled and then enable again.

1: the terminal running command is valid when powering on. If the running command is detected to be valid during powering on, the system will start the AC drive automatically after the initialization.

Note:

This function should be selected with cautions, or serious result may follow.

Function Code	Name	Setting Range	Default	Property
F01.17	Action if running frequency < frequency lower limit (Valid: > 0)	0: Run at lower limit frequency 1: Stop 2: Zero speed operation	0	⊙

0: Running at lower limit frequency.

1: Stop

2: Zero speed operation

Function Code	Name	Setting Range	Default	Property
F01.18	Zero speed operation restore delay Time	0.0~3600.0s (F01.17 = 2 is valid)	0.0s	○

When the AC drive is in zero speed operation state, if the setting frequency is above than the lower limit one again and it lasts for the time set by F01.18, then the AC drive will run automatically.

Function Code	Name	Setting Range	Default	Property
F01.19	Restart after power off	0~1	0	○

This function can enable the AC drive start or not after the power off and then power on.

0: Disable

1: Enable. If the starting need is met, the AC drive will run automatically after waiting for the time defined by F01.20.

Function Code	Name	Setting Range	Default	Property
F01.20	Waiting time of restart after power off	0.0~3600.0s (F01.19=1 is valid)	1.0s	○
F01.21	Start delay time	0.0 ~ 60.0s	0.0s	○

F01.19=1 valid, this function determines the waiting time before the automatic running of the AC drive when powering off and then powering on.

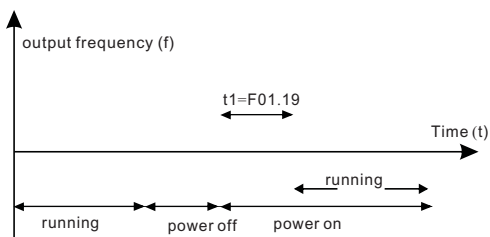

Function Code	Name	Setting Range	Default	Property
F01.22	Delay time of the stop speed	0.0~100.0s	0.0s	○

When the AC drive reaches the down speed, the AC drive shutdown after delay the time set by F01.22.

## Group F02 Motor Parameter Group

Function Code	Name	Setting Range	Default	Property
F02.00	Reserve	0	0	●

This parameter is reserved.

Function Code	Name	Setting Range	Default	Property
F02.01	Motor type	0	0	◎

0: General asynchronous motor without independent cooling fans, at low frequencies the cooling effect is poor, it will make the appropriate compensation when AC drive under thermal protection.

1: The frequency variable asynchronous motor has independent cooling fan and don't need low frequency compensation.

Function Code	Name	Setting Range	Default	Property
F02.02	Motor rated power	0.1~100.0kW	Model dependent	◎
F02.03	Motor rated voltage	0~1200V	Model dependent	◎
F02.04	Motor rated current	0.8~1000.0A	Model dependent	◎
F02.05	Motor rated frequency	0.01Hz~F00.03 (max frequency)	50.00Hz	◎
F02.06	Motor rated rotational speed	1~36000rpm	Model dependent	◎

The function parameter is used to set the asynchronous motor nameplate parameters. Regardless use the V / F control or vector control, in order to ensure the performance of control, it must be in accordance with the asynchronous motor nameplate parameter and set to the correct F02.02~F02.06 value. In addition, please be noted that, if the power of motor and AC drive standard fitness machine, the distribution power gap is too large (over two files of the power), that the control performance of the AC drive will significantly decreased as well.

Sd90 provides parameter auto-tuning function. Accurate parameter auto-tuning depends on proper setting of the motor nameplate parameters.

Note:

Reset the motor rated power (F02.02), you can initialize F02.04 ~ F02.08 motor parameters.

Function Code	Name	Setting Range	Default	Property
F02.07	Motor stator resistance	0.001~65.535Ω	Model dependent	○
F02.08	Motor no-load current	0.2~300.0A	Model dependent	○

F02.07~F02.08 is asynchronous motor identification parameters, these parameters are not showed in general motor nameplate, they need to obtain from AC drive's auto-tuning on motor parameters. Dynamic auto-tuning can acquire F02.07 ~ F02.08, static auto-tuning only gets F02.07 , the other parameter remains the factory default value.

Function Code	Name	Setting Range	Default	Property
F02.09	Overload protection selection	0~2	1	⊙

The validity of overload protection of motor 1 which set by F02.09.

0: NO protection

1: General motor protection

2: Variable frequency motor protection

Function Code	Name	Setting Range	Default	Property
F02.10	Overload protection coefficient	20.0%~120.0%	100.0%	○

Motor overload protection curve is inverse curves, motor electrical overload = F02.10 x motor rated current. When the actual load current < 110% x Motor overload current, overload protection invalid; when the actual load current = 116% x Motor overload current for 1 hour then overload fault will be reported; when the actual load current = 200% x motor overload current for 1 min, overload protection will be reported. The larger the overload coefficient, the shorter the time of overload fault will be reported is. Curves shown in the following figure:

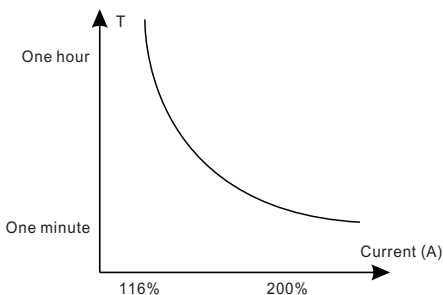

## Group F03 V/F Control Group

Function Code	Name	Setting Range	Default	Property
F03.00	V/F curve setting	0~4	0	⊙

0: Leaner V/F curve

1: Multiple-point V/F curve

2: 1.3th power low torque V/F curve

3: 1.7th power low torque V/F curve

4: 2.0th power low torque V/F curve

The various type of curves as shown in below,  $V_b$  in the below picture is the motor rated voltage and  $f_b$  is the rated frequency of the motor.

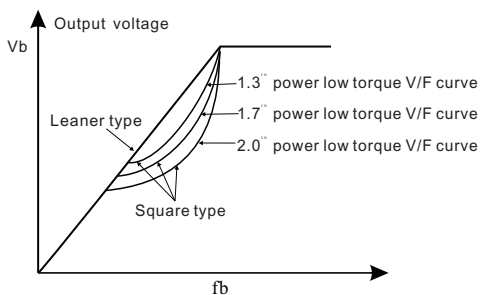

6

Function Code	Name	Setting Range	Default	Property
F03.01	Torque boost	0.0% (Automatic) 0.1%~20.0%	0.0%	○
F03.02	Torque boost close	0.0~50.0% (Relative to motor rated frequency)	20.0%	○



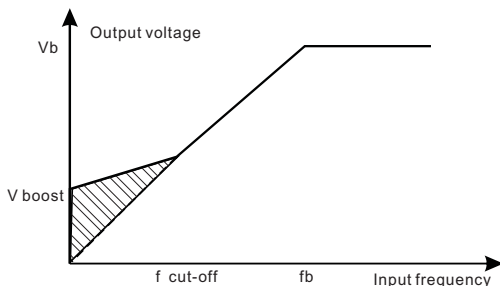

Torque boost to the output voltage for the features of low frequency torque. F03.01 is a percentage of the rated voltage  $V_b$ . In practical application, torque boost should be selected according to the load. The bigger the load is, the bigger the boost is. Too big torque boost is inappropriate because the motor will run with over-magnetic, and the current of the AV drive will increase to rise the temperature of the inverter and decrease the efficiency.

When the torque boost is set to 0.0%, the AC drive is automatic torque boost and the AC drive interior will according to the motor stator resistance value and the actual running current to make compensation for stator resistance voltage.

F03.02 define a manual cut-off frequency of torque boost is relative to percentage of the motor rated frequency  $f_b$ .

Torque boost threshold: under the threshold, the torque boost is valid, but over the threshold, the torque boost is invalid.

Function Code	Name	Setting Range	Default	Property
F03.03	V/F frequency point 1	0.00Hz~F03.05	00.00Hz	○
F03.04	V/F voltage point1	0.0~100.0% (Motor rated voltage)	00.0%	○
F03.05	V/F frequency point 2	F03.03~F03.07	00.00Hz	○
F03.06	V/F voltage point 2	0.0~100.0% (Motor rated voltage)	00.0%	○
F03.07	V/F frequency point 3	F03.05~F02.05 (Motor rated frequency)	00.00Hz	○

Function Code	Name	Setting Range	Default	Property
F03.08	V/F voltage point 3	0.0~100.0% (Motor rated voltage)	00.0%	○

When F03.00=1(multi-point V/F curve), the user can set V/F curve through F03.03~F03.08.V/F curve is generally set according to the load of the motor.

Note:

$V1 < V2 < V3$ ,  $f1 < f2 < f3$ . Too high low frequency voltage will heat the motor excessively or cause damage. The AC drive may stall when over-current or over-current protection.

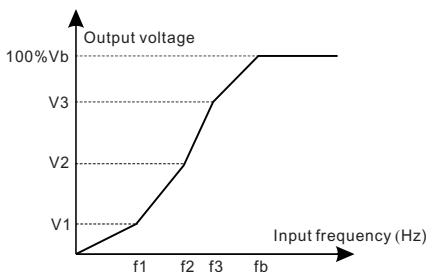

Function Code	Name	Setting Range	Default	Property
F03.09	V / F slip compensation gain	0.0~200.0%	100.0%	○

The function code is used to compensate the change of the rotation speed caused by load during compensation V/F control, especially effectively improved the speed control accuracy and output rotation speed at low frequency running so as to improve the rigidity of the motor. It can be set to rated slip frequency of the motor which is counted as below:

$$\Delta f = f_b \cdot n \times p / 60$$

Note:

$f_b$  is motor rated frequency and its function code is F02.05.n is motor rated speed and its function code is F02.06.p is pole pair of the motor. 100% of F03.09 corresponds to the motor rated slip frequency  $\Delta f$ .

Function Code	Name	Setting Range	Default	Property
F03.10	V / F slip compensation close frequency	0.00HZ~F00.03 (max frequency)	50.00Hz	○

When actual running frequency is higher than the frequency which is set by F03.10, V/F slip compensation is invalid.

Function Code	Name	Setting Range	Default	Property
F03.11	Low frequency suppression oscillation factor	0~30	2	○
F03.12	High frequency suppression oscillation factor	0~30	2	○
F03.13	Motor suppression oscillation demarcation point	0.00Hz~F00.03 (Max frequency)	30.00Hz	○

In V/F control mode, current fluctuation may occur to the motor at some frequency, especially the motor with big power. The motor can not run stably or overcurrent may occur. These phenomena can be canceled by adjusting this parameter.

Function Code	Name	Setting Range	Default	Property
F03.14	Reserved	-----	-	-
F03.15	Reserved	-----	-	-
F03.16	Reserved	-----	-	-
F03.17	Reserved	-----	-	-
F03.18	Reserved	-----	-	-
F03.19	Reserved	-----	-	-

Reserved.

Function Code	Name	Setting Range	Default	Property
F03.20	AVR function selection	0~1	1	○

0: Invalid

1: Valid in the whole process

This parameter sets the AVR function. When the AVR is valid and the input voltage of the power grid changes, SD90H AC drives will adjust automatically to maintain constant output voltage.

**Group F04 Input Terminal Group.**

Function Code	Name	Setting Range	Default	Property
F04.00	HDI input/AO output function selection	0~1	0	⊙

0: HDI input enable (See F04.23~F04.28)

1: HDI output enable (See F04.21)

Note: Setting of this function affects the terminals of control board HDI and AO. Users also need to configure the jumper selections by J5, J9.

Function Code	Name	Setting Range	Default	Property
F04.01	S1 terminal function selection	0~39	1	⊙
F04.02	S2 terminal function selection		4	⊙
F04.03	S3 terminal function selection		7	⊙
F04.04	S4 terminal function selection		0	⊙
F04.05	S5 terminal function selection		0	⊙
F04.06	Reserve		0	●

Input terminal function selection definition table

Function definition	Name
0	No function
1	Forward rotation operation
2	Reverse rotation operation
3	3-line running control
4	Forward jogging
5	Reverse jogging
6	Coast to stop

Input terminal function selection definition table

Function definition	Name
7	Fault reset
8	Operation pause
9	External fault input
10	Increasing frequency setting(UP)
11	Decreasing frequency setting (DOWN)
12	Frequency increase or decrease setting clear
13	Shift between A setting and B setting
14	Shift between combination setting and A setting
15	Shift between combination setting and B setting
16	Multi-stage speed terminal 1
17	Multi-stage speed terminal 2
18	Multi-stage speed terminal 3
19	Multi-stage speed terminal 4
20	Multi-stage speed pause
21	ACC/DEC time selection 1
22	ACC/DEC time selection 2
23	Reserve
24	Reserve
25	PID control pause
26	Reserve
27	Reserve
28	Counter reset
29	Reserve
30	ACC/DEC prohibited
31	Reserve
32	Reserve

Input terminal function selection definition table

Function definition	Name
33	Cancel frequency change setting temporarily
34	DC braking
35	Reserve
36	Shift the command to the keypad
37	Shift the command to the terminal
38	Shift the command to the communication
39	PID parameter switchover

Input terminal function selection definition table

Setting Value	Function	Instruction
0	No function	Even if there is a signal input, the AC drive will not move. Set 0 to avoid false operation.
1	Forward rotation operation	The terminal is used to control forward and reverse running of the AC drive.
2	Reverse rotation operation	
3	3-line running control	The terminal determines three-line control of the AC drive. For details, see description of F04.10.
4	Forward jogging	The jog frequency and ACC / DEC time are described respectively in F07.06, F07.07 and F07.08.
5	Reverse jogging	
6	Coast to stop	The drive blocks its output, the motor coast to reset and not controlled by the drive. This method can be taken when the large inertia load and the stopping time are not required.
7	Fault reset	The external is used for fault reset function, the same as the function of STOP/RESET key on the keypad. Remove fault reset is implemented by this function.
8	Operation pause	The AC drive decelerates to stop, but the running parameters are all memorized, such as PLC, swing frequency and PID parameters. After this function is disabled, the AC drive resumes its status before stop.
9	External fault input	If this terminal becomes ON, the AC drive reports fault and stop.

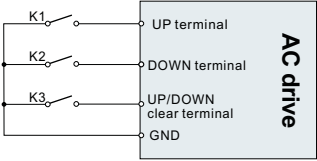
Setting Value	Function	Instruction								
10	Increasing frequency setting (Up)	<p>By the external terminal given frequency to modify the frequency increase and decrease instruction.</p> 								
11	Decreasing frequency setting (Down)									
12	Frequency increase or decrease setting clear	The frequency increase or decrease setting clear terminal can clear the frequency value of the auxiliary channel of the UP/DOWN in the AC drive, so that the given frequency can be recovered to a given frequency only by the primary frequency command channel.								
13	Shift between A setting and B setting	This function can achieve the shift between A frequency given and B frequency given channel.								
14	Shift between combination setting and B setting	This function can achieve the shift between the combination of the F00.10 settings set channel and A frequency given channel.								
15	Shift between combination setting and B setting	This function can achieve the shift between the combination of the F00.10 settings set channel and B frequency given channel.								
16	Multi-stage speed terminal 1	Through the combination of the four terminals digital state can achieve 16 speed settings.								
17	Multi-stage speed terminal 2	Note: Multi segment speed terminal 1 is low bit, multi segment speed terminal 4 is high bit.								
18	Multi-stage speed terminal 3	<table border="1" data-bbox="385 1007 929 1094"> <thead> <tr> <th>MS terminal 4</th> <th>MS terminal 3</th> <th>MS terminal 2</th> <th>MS terminal 1</th> </tr> </thead> <tbody> <tr> <td>BIT3</td> <td>BIT2</td> <td>BIT1</td> <td>BIT0</td> </tr> </tbody> </table>	MS terminal 4	MS terminal 3	MS terminal 2	MS terminal 1	BIT3	BIT2	BIT1	BIT0
MS terminal 4	MS terminal 3	MS terminal 2	MS terminal 1							
BIT3	BIT2	BIT1	BIT0							
19	Multi-stage speed terminal 4									
20	Multi-stage speed pause	Shielding multi-stage speed select terminal function to maintain the setting value in current status.								



Setting Value	Function	Instruction			
21	ACC and DEC time selection 2	Totally four groups of acceleration/deceleration time can be selected through status combinations of these two terminals.			
		<b>Terminal 2</b>	<b>Terminal 1</b>	<b>Acc/Dec time selection</b>	<b>Corresponding parameter</b>
22	ACC and DEC time selection 1	OFF	OFF	Acc/Dec time 1	F00.12/F00.13
		OFF	ON	Acc/Dec time 2	F07.00/F07.01
		ON	OFF	Acc/Dec time 3	F07.02/F07.03
		ON	ON	Acc/Dec time 4	F07.04/F07.05
23	Reserve	----			
24	Reserve	----			
25	PID control pause	PID is invalid temporarily. The AC drive maintains the current frequency output.			
26	Reserve	----			
27	Reserve	----			
28	Counter reset	This terminal is used to clear the counter status.			
29	Reserve	----			
30	ACC/DEC prohibited	It enables the AC drive to maintain the current frequency output without being affected by external signals (except the STOP command).			
31	Reserve	----			
32	Reserve	----			
33	Cancel frequency change setting temporarily	When the terminal close, the frequency value of the UP/DOWN can be cleared, and the fixed frequency can be recovered to a certain frequency. When the terminal is off, it return to the frequency value after increase or decrease setting.			
34	DC braking	DC braking time is the valid time of this function(Please set the relative DC braking parameters)			
35	Reserve	----			
36	Shift command to keypad	When the function terminal is effective, the operation command channel is forced to switch to the Keypad operation command channel, when function terminal is disabled, the command channel is restore to original state.			

Setting Value	Function	Instruction
37	Shift command to terminal control 1	When the function terminal is valid, the running command channel is forced to switch to the terminal running command channel 1 (Similar to the F00.01=1 function). When the terminal is invalid, the command channel is recovered to the original status.
38	Shift command to communication control	When the function terminal is effective, the operation command channel is forced to switch to the terminal operation command channel 2 (Similar to the F00.01=3 function). When the function terminal is disabled, the command channel is operated to restore to original state.
39	PID parameter switchover	Select PID parameter 2 when this function terminal is valid. Select PID parameter 1 when this function terminal is invalid.

Function Code	Name	Setting Range	Default	Property
F4.07	Polarity selection of input terminals	0x000~0x01F	0x000	○

This function code is used to set the polarity of the input terminals.

When the bit is set to 0, the input terminal is positive polarity.

When the bit is set to 1, the input terminal is negative polarity.

BIT4	BIT3	BIT2	BIT1	BIT0
S5	S4	S3	S2	S1

Function Code	Name	Setting Range	Default	Property
F04.08	ON-OFF filter time	0.000~1.000s	0.010s	○

Set the sample filter time of S1~S5. If the interference is strong, this parameter should be increased to avoid disoperation.

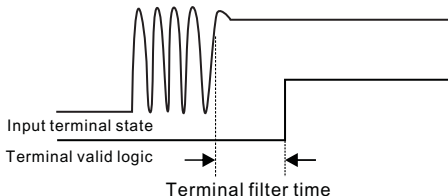

Function Code	Name	Setting Range	Default	Property
F4.09	Virtual terminal setting	0~1	0	⊙

0: Virtual terminal is invalid.

1: MODBUS communication virtual terminal is valid.

When MODBUS communication virtual terminal is valid, the input terminal port electrical level state is invalid to the multi-function of input terminals. The function state of input terminals is given by MODBUS setting. The address is set to 3009H. Related settings please refer to the Chapter 8 (MODBUS).

Function Code	Name	Setting Range	Default	Property
F4.10	Terminals control running modes	0~3	0	⊙

Set the running modes of terminals control.

0: Two-line control 1

Comply the enable with the direction. This mode is the most commonly used. FWD is forward running command input; REV is reverse running command input.

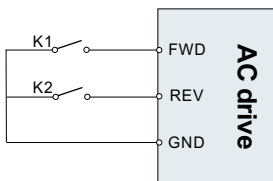

K1	K2	Running command
OFF	OFF	Stop
OFF	ON	Reverse
ON	OFF	Forward
ON	ON	Keep up

1: Two-line control 2

Separate the enable from direction. FWD is running command input, REV is direction control input.

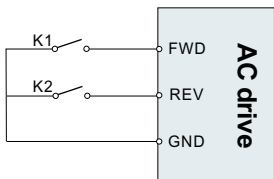

K1	K2	Running command
OFF	OFF	Stop
ON	OFF	Forward
OFF	ON	Stop
ON	ON	Reverse

### 2: Three-line control 1

Sn is enabled terminal on this mode, FWD is run command input(Pulse effective), REV is direction control input. In general, Sn connects to the normally closed button, FWD connects to the normally open button.

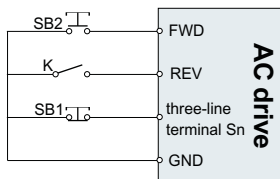

SB1	SB2	K	Running command
OFF	XX	XX	Stop
ON	ON	OFF	Forward
ON	ON	ON	Reverse
ON	OFF	XX	Keep up

### 3: Three-line control 2

Three-line control 2. Din is enabled terminal, direction is controlled by FWD, REV, but the pulse is valid, when power off, please disconnect Din terminal to finish the process..

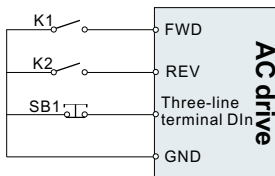

#### Note:

For the two-line running mode, when FWD / REV terminal is valid, the AC drive stops because of the stopping command from other sources, even the control terminal FWD / REV keeps valid; the AC drive won't work when the stopping

command is canceled. Only when FWD/REV is relaunched, the AC drive can start again. For example, the STOP/RESET stop is valid when PLC single cycles stop, fixed-length stop and terminal control.

Function Code	Name	Setting Range	Default	Property
F04.11	Switch-on delay of S1 terminal	0.000~50.000s	0.000s	○
F04.12	Switch-off delay of S1 terminal	0.000~50.000s	0.000s	○
F04.13	Switch-on delay of S2 terminal	0.000~50.000s	0.000s	○
F04.14	Switch-off delay of S2 terminal	0.000~50.000s	0.000s	○
F04.15	Switch-on delay of S3 terminal	0.000~50.000s	0.000s	○
F04.16	Switch-off delay of S3 terminal	0.000~50.000s	0.000s	○
F04.17	Switch-on delay of S4 terminal	0.000~50.000s	0.000s	○
F04.18	Switch-off delay of S4 terminal	0.000~50.000s	0.000s	○
F04.19	Switch-on delay of S5 terminal	0.000~50.000s	0.000s	○
F04.20	Switch-off delay of S5 terminal	0.000~50.000s	0.000s	○

The function code defines the corresponding delay time of the electrical level change during the programmable terminals from switching on or switching off.

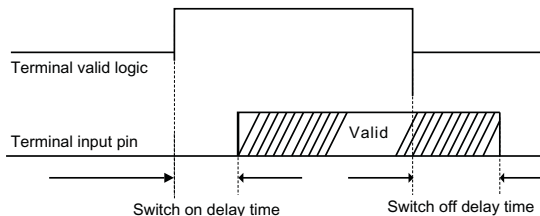

Function Code	Name	Setting Range	Default	Property
F04.21	Reserve	0	0	●
F04.22	Reserve	0	0	●

The two parameters are reserved.

Function Code	Name	Setting Range	Default	Property
F04.23	HDI high-speed pulse input function selection	0~2	0	◎

0: Frequency setting input

1: Counter input

2: Length counting input

Function Code	Name	Setting Range	Default	Property
F04.24	Lower limit frequency of HDI	0.00kHz~F04.26	0.00kHz	○
F04.25	Corresponding setting of lower limit frequency of HDI	-100.0~100.0%	0.0%	○
F04.26	Upper limit frequency of HDI	F04.24 ~50.00kHz	50.00kHz	○
F04.27	Corresponding setting of upper limit frequency of HDI	-100.0~100.0%	100.0%	○
F04.28	HDI frequency input filter time	0.000~10.000s	0.100s	○

When the HDI high-speed pulse input as a set frequency (F04.23=0), F04.24~F04.27 to set receive HDI of the upper and lower frequency, and its corresponding maximum frequency (F00.03) percentage.

HDI as set frequency in the frequency of A frequency instruction selection (F00.06), and B frequency source used in the instruction selection (F00.07).

F04.28 is used for setting HDI input filter time.

Function Code	Name	Setting Range	Default	Property
F04.29	Lower limit value of Ai1	0.00V~F04.31	0.00V	○
F04.30	Corresponding setting of lower limit of Ai1	-100.0~100.0%	0.0%	○
F04.31	Ai1 upper limit value	F04.29~10.00V	10.00V	○
F04.32	Corresponding setting of upper limit of Ai1	-100.0~100.0%	100.0%	○
F04.33	Ai1 input filter time	0.000~10.000s	0.100s	○

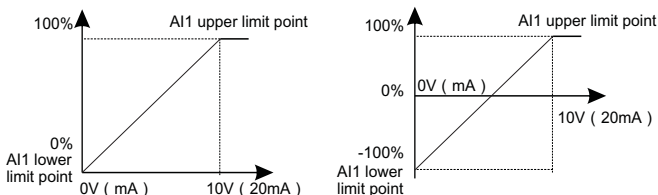

The corresponding curves of the Ai1 input analog

Input filter time: F04.33 is used to adjust the sensitivity of the analog input. Increasing the value properly can enhance the anti-interference of the analog, but weaken the sensitivity of the analog input.

#### Note:

Analog Ai1 can support 0~10V/0~20mA input. When Ai1 selects 0~20mA input, the corresponding voltage of 20mA is 10V.

Function Code	Name	Setting Range	Default	Property
F04.34	Keypad analog filter time	0.000~10.000s	0.100s	○

F04.34 sets the filter size of the keypad analog input. In the occasion with strong interference, it will result in large frequency fluctuation when setting frequency by keypad analog. Increasing the value of F04.34 properly can reduce frequency fluctuation.

## Group F05 Output Terminal Group

Function Code	Name	Setting Range	Default	Property
F05.00	Reserve	0	0	●

This parameter is reserved.

Function Code	Name	Setting Range	Default	Property
F05.01	Y output selection	0~24	1	○
F05.02	Reserve		0	●
F05.03	Relay RO output selection		1	○
F05.04	Reserve		0	●

Terminal Output Definition Table

Function definition	Name	Function definition	Name
0	Invalid	1	Running
2	Forward running	3	Reverse running
4	Jog running	5	AC drive fault
6	Frequency level detection FDT1	7	Frequency level detection FDT2
8	Frequency reached	9	Zero-speed running
10	Upper limit frequency reached	11	Lower limit frequency reached
12	Ready for running	13	Reserve
14	Overload pre-warning	15	Reserve
16	Completion of simple PLC stage	17	Completion of simple PLC cycle
18	Setup count value reached	19	Designated count value reached
20	External fault is valid	21	Length reached
22	Running time reached	23	MODBUS communication virtual terminal output
24	Torque arrival		

Output Terminal Explained in Details

Setting Value	Function	Instruction
0	Invalid	Output terminal has no function
1	Running	When the AC drive is running and has output frequency the terminal becomes ON.
2	Forward running	When the AC drive is forward running and has frequency output, the terminal becomes ON.



Setting Value	Function	Instruction
0	Invalid	Output terminal has no function
1	Running	When the AC drive is running and has output frequency the terminal becomes ON.
2	Forward running	When the AC drive is forward running and has frequency output, the terminal becomes ON.
3	Reverse running	When the AC drive is reverse running and has frequency output, the terminal becomes ON.
4	Jog running	When the AC drive is jog running and has frequency output, it would output ON signal.
5	AC drive fault	When the AC drive stops due to a fault, the terminal becomes ON.
6	Frequency level detection FDT1	Refer to the descriptions of F07.13 and F07.14
7	Frequency level detection FDT2	Refer to the descriptions of F07.15 and F07.16
8	Frequency reached	Refer to the descriptions of F08.17
9	Zero-speed running	When both output frequency and given frequency are zero, it would output ON signal.
10	Upper limit frequency reached	If the running frequency reaches the upper limit, the terminal becomes ON.
11	Lower limit frequency reached	If the running frequency reaches the lower limit, the terminal becomes ON.
12	Ready for running	If the AC drive main circuit and control circuit become stable, and the AC drive detects no fault and is ready for RUN, the terminal becomes ON.
13	Reserve	----
14	Overload pre-warning	When the AC drive's load in the above warning point, output ON signal after over pre-warning time. The specification refers to F0B.08~F0B.10.
15	Reserve	----
16	Completion of simple PLC stage	When simple PLC completes current phase, output signal.
17	Completion of simple PLC cycle	When simple PLC completes one cycle, output signal.

Setting Value	Function	Instruction
18	Setup count value reached	The terminal becomes ON when the count value exceeds the value set in F09.10.
19	Designated count value reached	The terminal becomes ON when the count value exceeds the value set in F09.11.
20	External fault is valid	When the external fault EF occurs, output ON signal.
21	Length reached	The terminal becomes ON when the detected actual length exceeds the value set in F09.04.
22	Running time reached	When the total running time of the AC drive exceeds the setting time in F09.12 , output ON signal.
23	MODBUS communication virtual terminal output	Output signal is set according to the setting value of MODBUS,1 for ON signal, 0 for OFF signal.
24	Torque arrival	When actual torque value arrives at the setting value of F09.14, output ON signal

Function Code	Name	Setting Range	Default	Property
F05.05	Polarity of output terminals	0x0~0x3	0x0	○

This function code is used to set the polarity of the input terminals.

When the bit is set to 0, the input terminal is positive polarity.

When the bit is set to 1, the input terminal is negative polarity.

BIT3	BIT2	BIT1	BIT0
0	0	R0	Y

Function Code	Name	Setting Range	Default	Property
F05.06	Y switch-on delay time	0.000~50.000s	0.000s	○
F05.07	Y switch-off delay time	0.000~50.000s	0.000s	○
F05.08	Relay RO switch-on delay time	0.000~50.000s	0.000s	○

Function Code	Name	Setting Range	Default	Property
F05.09	Relay RO switch-off delay time	0.000~50.000s	0.000s	○

The function code defines the corresponding delay time of the electrical level change during the programmable terminals from switching on or switching off.

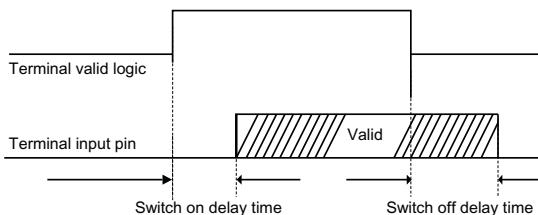

Function Code	Name	Setting Range	Default	Property
F05.10	AO output selection	0~14	0	○

Analog or High-Speed Pulse Output Definition Table

Function definition	Name	Function definition	Name
0	Running frequency	1	Set frequency
2	Ramp reference frequency	3	Running speed
4	Output current (relative to AC drive rated current)	5	Output current (relative to motor rated current)
6	Output voltage	7	Output power
8	Reserve	9	Output torque
10	Analog AI1 input value	11	Reserve
12	Reserve	13	High-speed pulse HDI input value
14	MODBUS communication setting value		

The Output Range of Analog or High-Speed Pulse

Setting Value	Function	Instruction
0	Running frequency	0 to Maximum output frequency (Corresponding to 0~100%)
1	Set frequency	0 to Maximum output frequency (Corresponding to 0~100%)

Setting Value	Function	Instruction
2	Ramp reference frequency	0 to Maximum output frequency (Corresponding to 0~100%)
3	Running speed	0~2 times of motor rated synchronous speed (Corresponding to 0~100%)
4	Output current (Relative to AC drive rated current)	<b>0~2 times of AC drive rated current (Corresponding to 0~100%)</b>
5	Output current (Relative to motor rated current)	0~2 times of motor rated current (Corresponding to 0~100%)
6	Output voltage	0~1.5 times of AC drive rated voltage (Corresponding to 0~100%)
7	Output power	0~2 times of rated power (Corresponding to 0~100%)
8	Reserve	-----
9	Output torque	0~2 times of motor rated current (Corresponding to 0~100%)
10	Analog AI1 input value	0~10V/0~20mA (Corresponding to 0~100%)
11	Reserve	-----
12	Reserve	-----
13	High-speed pulse HDI input value	0~Maximum pulse input frequency ( 0~100% )
14	MODBUS communication setting value	0.0%~100.0% (Corresponding to 0~100%)

Function Code	Name	Setting Range	Default	Property
F05.11	Lower output limit of AO	0.0%~F05.13	0.0%	○
F05.12	Corresponding AO output of lower limit	0.00~10.00V	0.00V	○
F05.13	Upper output limit of AO	F05.11~100.0%	100.0%	○
F05.14	Corresponding AO output of upper limit	0.00~10.00V	10.00V	○
F05.15	Ao output filter time	0.000~10.000s	0.000s	○

The above function codes define the relative relationship between the output value and the analog output. When the output value exceeds the range of setting maximum or minimum output, it will count according to by upper limit or lower limit output.

When the analog output is current output , 1mA equals to 0.5V.

In different cases, the corresponding analog output of 100% of the output value is difference. See The Output Range of Analog or High-Speed Pulse Table above.

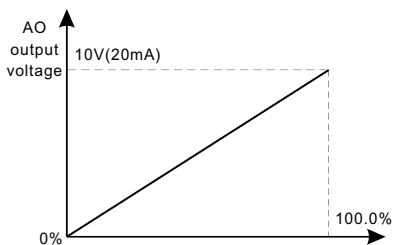

## Group F06 HMI Group

Function Code	Name	Setting Range	Default	Property
F06.00	User's password	0~65535	0	○

The password protection is valid when setting any non-zero number.

0.0.0.0.0:Clear the previous user's password, and make the password protection invalid.

After the user password setting is valid, if the password is incorrect, users cannot enter the parameter menu. Only correct password can make users check and modify the parameters. Please remember all users' passwords.

Retreat editing state of the function codes and the password protection will become valid in one minute. If the password is available, press PRG key to access the editing status of function codes and then 0.0.0.0.0 will be displayed. Unless input right password, the operator can not enter the into it.

Function Code	Name	Setting Range	Default	Property
F06.01	S key function selection	0~6	1	⊙

0: No function

1: Jog running. Press S key to begin the jogging running.

2: Shift the display state by the shifting key. Press S key to shift the displayed function code from right to left.

3: Shift between forward rotations and reverse. Press S key to shift the direction of frequency commands. The function is only is valid in the keypad command channels.

4: Clear UP / DOWN settings. Press S key to clear the set value of UP / DOWN.

5: Coast to stop. Press S key to coast to stop.

6: Command source switch.

### Note:

Press S key to shift between forward rotation and reverse rotation, the AC drive does not remember the state after shifting during powering off.

The AC drive will in the running direction set according to parameter F00.14 during next powering on.

S key function set as 6:

When F00.01 set as 0, S key command source switch is invalid.

When F00.01 set as 1 or 2 (terminal), S key can achieve the switch between terminals and operation panels.

When F00.01 set as 3 or 4 (communication), S key can achieve the switch between communication and operation panels.

Function Code	Name	Setting Range	Default	Property
F06.02	Reserved	-----	-	-

Reserved.

Function Code	Name	Setting Range	Default	Property
F06.03	STOP/RESET stop function selection	0~3	0	○

0: Only valid for keypad control

1: Both valid for keypad and terminal control

2: Both valid for keypad and communication control

3: Valid for all control modes

Users can select STOP/RESET key on the control panel to determine it's valid for what part.

Function Code	Name	Setting Range	Default	Property
F06.04	Parameters state 1	0x0000~0xFFFF	0x03FF0	○

F06.04 Parameter Setting Function Table

Parameters State 1			
Bit0	Running frequency (Hz ON)	Bit1	Setting frequency (Hz blinking)
Bit2	Bus voltage	Bit3	Output voltage
Bit4	Output current (A ON)	Bit5	Running speed
Bit6	Output power	Bit7	Output torque
Bit8	PID reference value	Bit9	PID feedback value

F06.04 Parameter Setting Function Table (Continue)

Parameters State 1			
Bit10	Input terminal state	Bit11	Output terminal state
Bit12	Pulse count value	Bit13	Length value
Bit14	The current stage in Multi-stage speed	Bit15	Analog AI1 value

Function Code	Name	Setting Range	Default	Property
F06.05	Parameters state 2	0x0000~0xFFFF	0x0000	○

F06.05 Parameter Setting Function Table

Parameters State 2			
Bit0	High-spped pulse HDI frequency	Bit1	Motor overload percentage
Bit2	AC drive overload percentage	Bit3	Ramp frequency setting value (Hz is ON)
Bit4	Linear speed current (A ON)	Bit5	Bit5~15

Function Code	Name	Setting Range	Default	Property
F06.06	Parameters for stopping state	0x0000~0x07FF	0x00FF	○

F06.06 Parameter Setting Function Table

Parameters for stopping state			
Bit0	Set frequency (Hz is fliking slowly)	Bit1	Bus voltage
Bit2	Input terminal state	Bit3	Output terminal state
Bit4	PID reference value	Bit5	PID feedback value
Bit6	Analog AI1 value	Bit7	High-spped pulse HDI frequency
Bit8	The current stage in Multi-stage speed	Bit9	Pulse count value
Bit10	Length value	Bit11~15	Reserved



Function Code	Name	Setting Range	Default	Property
F06.07	Frequency display coefficient	0.01~20.00	1.00	○
F06.08	Rotation speed display coefficient	0.1~999.9%	100.0%	○
F06.09	Linear speed display coefficient	0.1~999.9%	1.0%	○

Displayed frequency=Running frequency× F06.07;

Mechanical rotation speed=60× running frequency×F06.08/Motor pole pairs;

Linear speed = Mechanical rotation speed × F06.09.

Function Code	Name	Setting Range	Default	Property
F06.10	Reserve	0	0	●

This parameter is reserved.

Function Code	Name	Setting Range	Default	Property
F06.11	Converter module temperature	-20.0~120.0°C	-	●
F06.12	Control board software version	1.00~655.35	-	●

These two parameters can be view, but can not be modified.

Function Code	Name	Setting Range	Default	Property
F06.13	Cumulative running time of the unit	0-65535h	0	○
F06.14	Reserve	0	0	●

Function Code	Name	Setting Range	Default	Property
F06.15	AC drive rated power	0.4~100.0kW	-	●
F06.16	AC drive rated voltage	50~1000V	-	●
F06.17	AC drive rated current	0.1~1000.0A	-	●

These parameters can be view, but can not be modified.

Function Code	Name	Setting Range	Default	Property
F06.18	Current fault type	-	-	●
F06.19	Previous 1 fault type	-	-	●
F06.20	Previous 2 fault type	-	-	●

The detailed description refers to AC drive fault instructions and solutions in chapter 7.

Function Code	Name	Setting Range	Default	Property
F06.21	Running frequency at current fault	---	0.00Hz	●
F06.22	Ramp reference frequency at current fault	---	0.00Hz	●
F06.23	Output voltage at current fault	---	0V	●
F06.24	Output current at current fault	---	0.0A	●
F06.25	Bus voltage at current fault	---	0.0V	●
F06.26	The Max. temperature at current fault	---	0.0°C	●
F06.27	Input terminals state at current fault	---	0	●

Function Code	Name	Setting Range	Default	Property
F06.28	Output terminals state at current fault	---	0	●

The above parameters record the record values of internal variable and input/output variables of the AC drive when current fault occurs. please refer to the function code specifically.

Function Code	Name	Setting Range	Default	Property
F06.29	Running frequency at previous fault	---	0.00Hz	●
F06.30	Ramp reference frequency at previous fault	---	0.00Hz	●
F06.31	Output voltage at previous fault	---	0V	●
F06.32	Output current at previous fault	---	0.0A	●
F06.33	Bus voltage at previous fault	---	0.0V	●
F06.34	The Max. temperature at previous fault	---	0.0°C	●
F06.35	Input terminals state at previous fault	---	0	●
F06.36	Output terminals state at previous fault	---	0	●

These parameters record the AC drive internal variables at previous fault, the record of the input and output variables, referring to the function code specifically.

### Group F07 Enhancement Group

Function Code	Name	Setting Range	Default	Property
F07.00	Acceleration time 2	0.0~3600.0s	Model dependent	○
F07.01	Deceleration time 2	0.0~3600.0s	Model dependent	○
F07.02	Acceleration time 3	0.0~3600.0s	Model dependent	○
F07.03	Acceleration time 3	0.0~3600.0s	Model dependent	○
F07.04	Deceleration time 4	0.0~3600.0s	Model dependent	○
F07.05	Acceleration time 4	0.0~3600.0s	Model dependent	○

SD90 series define 4 groups of Acc/Dec time which can be selected by F04 group.

The first group of Acc/Dec time is the factory default one.

Function Code	Name	Setting Range	Default	Property
F07.06	Jogging frequency	0.00~F00.03 (Max. frequency )	5.00Hz	○

The parameter is used to define the reference frequency of the AC drive during jogging.

6

Function Code	Name	Setting Range	Default	Property
F07.07	Jogging ACC time	0.0~3600.0s	Model dependent	○
F07.08	Jogging DEC time	0.0~3600.0s	Model dependent	○

The jogging acceleration time means the time needed if the AC drive runs from 0Hz to the maximum output frequency (F00.03) during jogging.

The jogging deceleration time means the time needed if the AC drive runs from the maximum output frequency (F00.03) to 0Hz during jogging.

Function Code	Name	Setting Range	Default	Property
F07.09	Fault auto reset times	0~10	0	○
F07.10	Interval time of fault auto reset	0.1~3600.0s	1.0s	○

#### Fault auto reset times

Set automatic fault reset times. If the reset time exceeds this set value, the AC drive will stop to wait maintenance. When can not reset also calculate the number of times.

#### Interval time of fault auto reset

The interval between the time when the fault occurs and the time when reset action occurs.

Function Code	Name	Setting Range	Default	Property
F07.11	Reserve	0	0	●
F07.12	Reserve	0	0	●

These two parameters are reserved.

Function Code	Name	Setting Range	Default	Property
F07.13	FDT1 electrical level detection value	0.00~F00.03 (Max. frequency)	50.00Hz	○
F07.14	FDT1 retention detection value	0.0~100.0% (FDT1 level)	5.0%	○
F07.15	FDT2 electrical level detection value	0.00~F00.03 (Max. frequency)	50.00Hz	○
F07.16	FDT2 retention detection value	0.0~100.0% (FDT2 level)	5.0%	○

When the output frequency exceeds corresponding frequency of FDT electrical level, the multi- function digital output terminals will output the signal of “frequency level detect FDT” until the output frequency decreases to a value lower than (FDT electrical level-FDT retention detection value) the corresponding frequency, the signal is invalid.

Below is the wave form diagram:

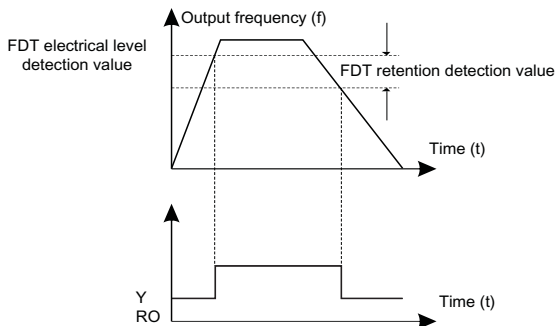

Function Code	Name	Setting Range	Default	Property
F07.17	Frequency arrival detection value	0.0~F00.03 (Max. frequency )	0.00Hz	○

When the output frequency is among the positive and negative detection range of the set frequency, the multi-functional digital output terminal output the signal of "Frequency arrival". See the diagram below for detailed information:

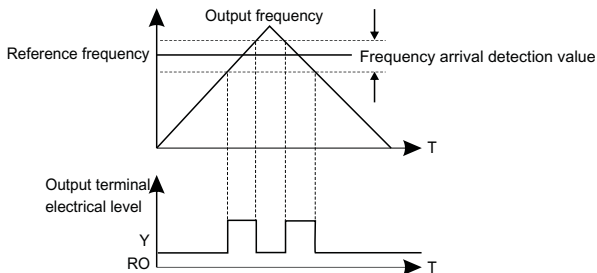

Function Code	Name	Setting Range	Default	Property
F07.18	Energy braking enable	0~1	1	○

This parameter is used to control the internal braking pipe inside the AC drive.

0: Energy braking is prohibit.

1: Energy braking is enable.

**Note:**

Only applied for internal brake pipe models.

Function Code	Name	Setting Range	Default	Property
F07.19	Threshold voltage of energy braking	200.0~1000.0V	220V level:380.0V	○
			380V level:700.0V	

After setting the original bus voltage to energy braking, adjust the value appropriately to achieve the effective brake of the load to prevent over-voltage fault in power state. The factory value varies with the changes of the voltage.

Function Code	Name	Setting Range	Default	Property
F07.20	Reserve	0	0	●

This parameter is reserved.

Function Code	Name	Setting Range	Default	Property
F07.21	Over commission selection	0~1	0	⊙

0: Over commission is valid.

1: Over commission is invalid

This parameter is used to set whether the over commission of the output voltage waveform is valid.

Function Code	Name	Setting Range	Default	Property
F07.22	Keypad digital control setting	0x000~0x1221	0x0001	○
F07.23	Integral ratio of the keypad $\Delta / V$	0.01~10.00s	0.10s	○

F07.22 Parameter Setting Function Table

Keypad Digital Control Setting Instruction	
LED ones	Frequency control selection 0: $\wedge$ / $\vee$ keys adjustment is invalid 1: $\wedge/\vee$ keys adjustment is valid
LED tens	Frequency control selection 0: Only valid for F00.06=0 or F00.07=0 setting 1: Valid for all frequency modes 2: Invalid for multi-stage speed when multi-stage speed is in priority
LED hundreds	Stop action selection 0: Setting is valid 1: Valid during running, cleared after stopping 2: Valid during running, cleared after receiving the stop command.
LED thousands	$\wedge$ / $\vee$ key integral function 0: Integral function is valid 1: Integral function is invalid

Function Code	Name	Setting Range	Default	Property
F07.24	UP/DOWN terminal control setting	0x00~0x221	0x000	○

F07.24 Parameter Setting Function Table

UP/DOWN Terminal Control Setting Instruction	
LED ones	Frequency control selection 0: UP/DOWN terminal setting is valid 1: UP/DOWN terminal setting is invalid
LED tens	Frequency control selection 0: Only valid for F00.06=0 or F00.07=0 setting 1: Valid for all frequency modes 2: Invalid for multi-sted when multi-sted is priority
LED hundreds	Action selection when stop 0: Setting is valid 1: Valid in running, clear after stop 2: Valid in running, clear after receiving stop commands

Function Code	Name	Setting Range	Default	Property
F07.25	Up terminal frequency changing ratio	0.01~50.00s	0.50s	○



Function Code	Name	Setting Range	Default	Property
F07.26	DOWN terminal frequency changing ratio	0.01~50.00s	0.50s	○

When the above two parameters is valid during the control of the terminal UP/DOWN frequency, set the allowance integral effect, the smaller the value is, the quicker the integral rate.

Function Code	Name	Setting Range	Default	Property
F07.27	Frequency setting at power loss	0x000~0x011	0x000	○

F07.27 Parameter Setting Function Table

UP/DOWN Terminal Control Setting Instruction	
LED ones	Action selection when power off 0: Save when power off 1: Clear when power off
LED tens	Action selection when MODBUS set frequency power off 0: Save when power off 1: Clear when power off

Function Code	Name	Setting Range	Default	Property
F07.28	Magnetic flux braking	0: Valid; 1~100: Invalid	0	○

This parameter is used to enable the magnetic flux braking.

0: Invalid

1~100: Valid, the bigger the coefficient, the stronger the braking is.

When increase the magnetic flux to decelerate the motor, the energy generated by the motor during braking can be converter into heat energy by increasing the magnetic flux. With this function, decelerating time is shorten while running current is larger. When magnetic flux braking with no actions, motor speed decreasing while the decreasing time is longer.

Function Code	Name	Setting Range	Default	Property
F07.29	PWM modulation mode	0: 3-phase modulation 1: 2/3 -phase modulation switchover	1	⊙

0: 3 phase modulation

1: 2/3 phase modulation switching

### Group F08 PID Control Group

Function Code	Name	Setting Range	Default	Property
F08.00	PID reference source selection	0~5	0	○

0: Keypad digital reference (F08.01)

1: Analog channel Ai1 reference

2: Reserve

3: High-speed pulse HDI reference

4: MS reference

5: MODBUS communication reference

#### Note:

Multi-stage speed given, it is realized by setting F0A group parameters.

6

Function Code	Name	Setting Range	Default	Property
F08.01	Keypad preset PID reference	-100.0~100.0%	50.0%	○

When F08.00 = 0, PID reference is keypad digital reference, set the parameter F08.01 whose basic value is the feedback of the system.

Function Code	Name	Setting Range	Default	Property
F08.02	PID feedback source selection	0~3	0	○

0: Analog channel AI1 feedback

1: Reserve

2: High-speed pulse HDI feedback

3: MODBUS communication feedback

**Note:**

Reference channel and feedback channel can not coincide, otherwise, PID can not control effectively.

Function Code	Name	Setting Range	Default	Property
F08.03	PID output feature selection	0: PID output is positive 1: PID output is negative	0	○

0: PID output is positive feature: when the feedback signal exceeds the PID given value, the output frequency of the AC drive will decrease to balance the PID. For example, the strain PID control during wrapup.

1: PID output is negative feature: when the feedback signal exceeds the PID given value, the output frequency of the AC drive will increase to balance the PID. For example, the strain PID control during wrapdown.

Function Code	Name	Setting Range	Default	Property
F08.04	Proportional gain (Kp 1)	0.00~100.00	0.50	○

This function is applied to proportional gain 1 (Kp1) of the PID adjuster. Kp1 determines the strength of the PID. The larger the Kp1 value, the stronger the adjustment is. The parameter of 100 means that when the offset of PID feedback and given value is 100%, the adjusting range of PID adjuster is the maximum frequency (Ignoring integral action and differential function).

Function Code	Name	Setting Range	Default	Property
F08.05	Integral time1(Ti1)	0.01~10.00s	0.20s	○

This function is applied to integral time1(Ti1) of the PID adjuster. Ti1 determines the speed of the PID adjuster to carry out the integral adjustment on the deviation of PID feedback and reference.

When the offset of PID feedback and reference is 100%, the integral adjuster works continuously after the time (Ignoring proportional effect and differential effect) to achieve the maximum frequency (F00.03) or the maximum voltage (F03.18). The shorter the integral time, the stronger the adjustment is.

Function Code	Name	Setting Range	Default	Property
F08.06	Differential time 1 (Td1)	0.00~10.00s	0.00s	○

This function is applied to differential time1 (Td1) of the PID adjuster. Td1 determines the strength of the change ratio when PID adjuster carries out the integral adjustment on the deviation of PID feedback and reference.

If the PID feedback quantity changes 100% during the time, the adjustment of integral adjuster (Ignoring the proportional effect and integral effect) is the maximum frequency (F00.03) or the maximum voltage (F03.18). The longer the differential time, the stronger the adjustment is.

Function Code	Name	Setting Range	Default	Property
F08.07	Sampling cycle (T)	0.00~10.00s	0.10s	○

Sampling period (T) is the sampling cycle of the PID feedback. The PID operates once in each sampling cycle. The longer the sampling cycle is, the slower the response of PID adjuster is. The shorter the sampling cycle is, the faster the response of PID adjuster is.

Function Code	Name	Setting Range	Default	Property
F08.08	PID control deviation limit	0.0~100.00%	0.0%	○

Starting PID adjuster required the minimum deviation value of PID feedback and the reference. When the deviation is less than the limit deviation, PID adjuster stops to work. When the deviation is greater than the limit deviation value, PID adjuster starts to adjust. Set the function properly to adjust accuracy and stability of the PID system.

Function Code	Name	Setting Range	Default	Property
F08.09	Output upper limit of PID	F08.10~100.0% (Max. frequency or voltage )	100.0%	○
F08.10	Output lower limit of PID	-100.0%~F08.09	0.0%	○

It used to set the upper and lower limit of the PID adjustor output.

100% corresponds to the maximum output frequency (F00.03) or maximum voltage (F03.18)

Function Code	Name	Setting Range	Default	Property
F08.11	Detection value of feedback offline	0.0~100.0%	0.0%	○
F08.12	Detection time of feedback offline	0.0~3600.0s	1.0s	○

Set the detection value of PID feedback offline. When the feedback detection value is smaller or equal to the detected value, and the lasting time exceeds the set value in F08.12, the AC drive will report "PID feedback offline fault" and the keypad will display "PIDE".

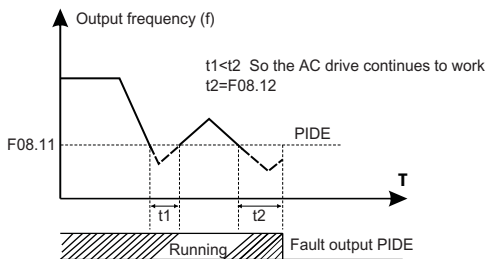

Function Code	Name	Setting Range	Default	Property
F08.13	PID adjustment selection	0×00~0×11	0x00	○

F08.13 Parameter Setting Function Table

PID Adjustment Selection Instruction	
LED ones	<p>0: Keep on integral adjustment when the frequency achieves the upper and lower limit.</p> <p>The integration shows the change between the reference and the feedback unless it reaches the internal integral limit. When the trend between the reference and the feedback changes, it needs more time to offset the impact of continuous working and the integration will change with the trend.</p> <p>1: Stop integral adjustment when the frequency achieves the upper and lower limit. If integration keeps stable, and the trend between the reference and the feedback changes, the integration will change with the trend quickly.</p>
LED tens	<p>0: The same with the setting direction. If the output of PID adjustment is different from the current running direction, the internal will output 0 forcedly.</p> <p>1: Opposite to the setting direction. If the output of PID adjustment is different from the current running direction, carry out the closed-loop adjusted output with the opposite direction to the current setting.</p>

Function Code	Name	Setting Range	Default	Property
F08.14	Proportional gain 2 (Kp2)	0.00~100.00	0.50	○
F08.15	Integral time 2 (Ti2)	0.00~10.00s	0.20s	○
F08.16	Differential time 2 (Td2)	0.00~10.00s	0.00s	○

The above 3 parameters are the second group of proportional, integral and derivative parameters of the PID adjustor. The function and significance is similar to group 1 parameters's (F08.04, F08.05, F08.06). The switch of the two group parameters is set by F08.17.

Function Code	Name	Setting Range	Default	Property
F08.17	Switchover selection of PID	0~2	0	⊙

The parameter is used for switching the 2 sets parameters of PID (Kp1, Ti1,Td1 and Kp2,Ti2,Td2).

0: Without switch, only used for the first set of parameters (F08.04, F08.05, F08.06).

1: Switch according to the deviation of PID feedback and setting value. Deviation threshold is set by F08.18. When the deviation is smaller than F08.18, use the first set of parameters F08.04, F08.05, F08.06. When the deviation is greater than F08.18, using the second set of parameters F08.14, F08.15, F08.16.

2: Switch according to output terminal. When the output terminal "PID parameter switch" is OFF, use the first set of parameters F08.04, F08.05, F08.06. When the output terminal "PID parameter switch" is ON, use the second set of parameters F08.14, F08.15, F08.16.

Function Code	Name	Setting Range	Default	Property
F08.18	Input deviation threshold when PID switching	0.0~100.00%	20%	○

When F08.17=1, F08.18 is used for setting input deviation threshold for PID switching.

Function Code	Name	Setting Range	Default	Property
F08.19	PID initial value	-100.0%~100.0%	0.0%	○
F08.20	PID initial holding time	0.0~600.0s	0.0s	○

When the AC drive starts up, the PID starts closed-loop algorithm only after the PID output is fixed to the PID initial value (F08.19) and lasts the time set in F08.20.

PID initial value function as below:

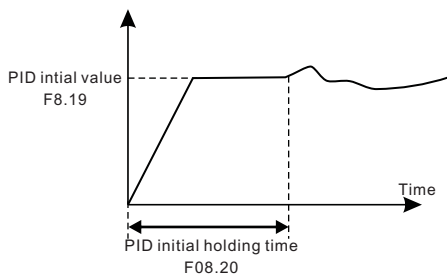



## PID control flow diagram:

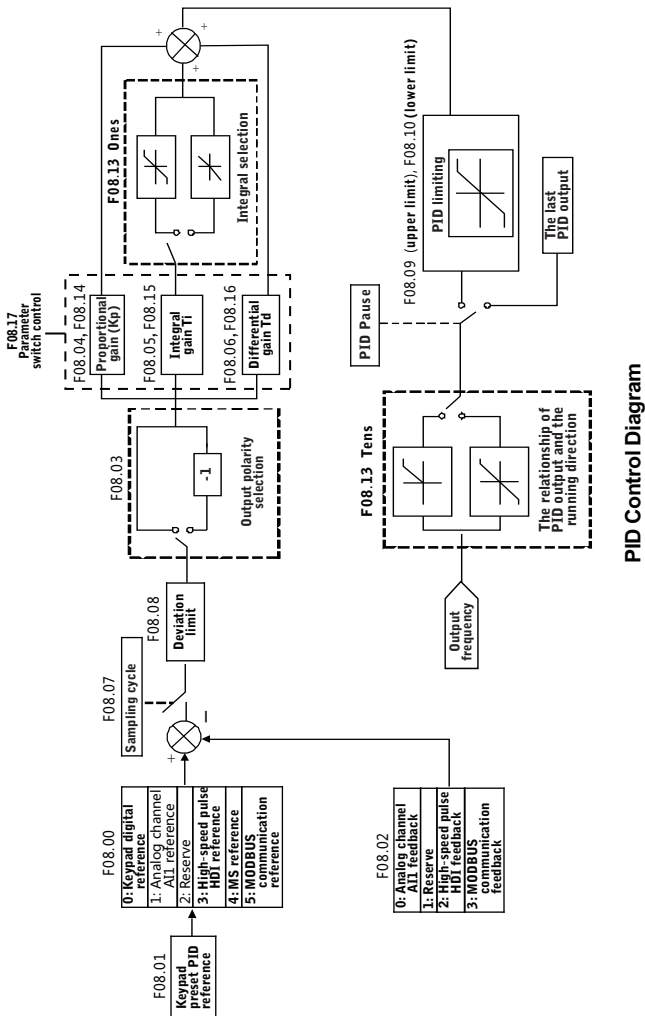

PID Control Diagram

## Simple Illustration of the PID Control Operation and Adjustment

### Proportional adjustment (Kp):

When there is a deviation between the feedback and reference, a proportional adjustment will be output. If the deviation is constant, the adjustment will be constant, too. Proportional adjustment can respond to the feedback change quickly, but it can not realize non-fault control. The proportional gain will increase with the adjustment speed, but too much gain may cause vibration. The adjustment method is: set a long integral time and derivative time to 0 first. Secondly make the system run by proportional adjustment and change the reference. And then watch the deviation of the feedback signal and the reference. If the static deviation is available (for example, increasing the feedback reference, the feedback will be less than the reference after a stable system), continue to increase the proportional gain, vice verse. Repeat the action until the static deviation achieves a little value.

### Integral time(Ti):

When there is a deviation between the feedback and reference, the output adjustment will accumulate. The adjustment will keep on increasing until the deviation disappears. The integral adjustor can cancel the static deviation effectively. Vibration may occur as a result of unstable system caused by repeated over-adjusted if the integral adjustor is too strong. The features of kind of vibration are: the fluctuating feedback signal (around the reference) and increasing swing range will cause vibration. Adjust the integral time parameter from a big value to a little one to change the integral time and monitor the result until a stable system speed is available.

### Differential time(Td):

When the deviation between the feedback and reference has changed, a proportional adjustment of output and deviation will be output. The adjustment only depends on the direction and value of the deviation change rather than the deviation itself. The differential adjustment controls the change of feedback signals according to the changing trend when it fluctuates. Because the differential adjustment may enlarge the interference to the system, especially the frequent-changing interference, please use it carefully. When F00.06, F00.07= 8 or F03.14= 6, the running mode of the AC drive is procedure PID control.

**General steps of PID parameters setting:**

## a. Ensure the proportional gain P

When ensure the proportional gain P, firstly remove the PID integration and differentiation (set  $T_i=0$  and  $T_d=0$ , see the PID parameter setting for detailed information) to make proportional adjustment is the only method to PID. Set the input as 60%~70% of the permitted maximum value and increase gain P from 0 until the system vibration occurs, vice versa, and record the PID value and set it to 60% to 70% of the current value. Then the proportional gain P commission is finished.

b. Ensure the integral time  $T_i$ 

After ensuring the gain P, set an original value of a bigger integral time and decrease it until the system vibration occurs, vice versa, until the system vibration disappear. Record the  $T_i$  and set the integral time to 150%~180% of the current value. Then integral time commission is finished.

c. Ensure the differential time  $T_d$ 

Generally, it is not necessary to set  $T_d$  which is 0.

If it needs to be set, set it to 30% of the value without vibration via the same method with P and  $T_i$ .

d. Commission the system with and without load and then adjust the PID parameters until it is available.

**PID Inching:**

After setting the parameters of PID control, inching is possible by following means.

Control the overshoot: shorten the differential time( $T_d$ ) and prolong the integral time( $T_i$ ) when overshoot occurs.

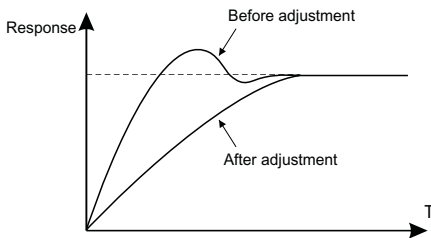

Reduce the stability time: shorten the integral time ( $T_i$ ) and prolong the derivative time ( $T_d$ ) even the overshoot occurs, but the control should be stable as soon as possible.

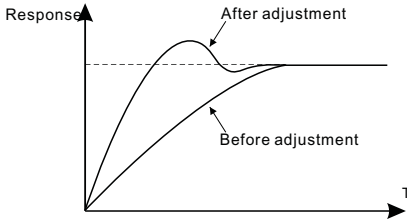

Control long vibration: If the vibration periods are longer than the set value of integral time ( $T_i$ ), it is necessary to prolong the integral time ( $T_i$ ) to control the vibration for the strong integration.

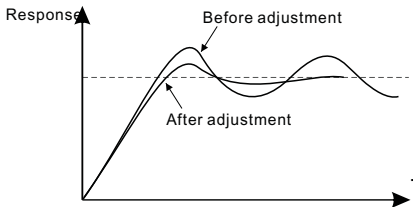

6

Control short vibration: Short vibration period and the same set value with the differential time ( $T_d$ ) mean that the differential time is strong. Shortening the differential time ( $T_d$ ) can control the vibration. When setting the differential time as 0.00 (no differential control) is useless to control the vibration, decrease the gain.

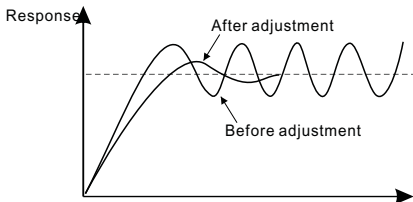

**Group F09****Swing Frequency ,Fixed-length Count and Fixedtime**

Function Code	Name	Setting Range	Default	Property
F09.00	Reserve	0	0	●
F09.01	Reserve	0	0	●
F09.02	Reserve	0	0	●
F09.03	Reserve	0	0	●

F09.00~F09.03 are reserved.

Function Code	Name	Setting Range	Default	Property
F09.04	Set length	0~65535m	0m	○
F09.05	Actual length	0~65535m	0m	●

The functional codes of setting length, actual length and the unit pulse are mainly used to fix length.

The length is calculated by the pulse signal of HDI1 terminals input and the HDI1 terminals are needed to set as the length counting input.

Actual length=Length counting input pulses/Unit pulses.

When the actual length F09.05 exceeds the setting length F09.04, the multi-function digital out terminal will output ON.

Function Code	Name	Setting Range	Default	Property
F09.06	Pulse per rotation	1~10000	1	
F09.07	Alxe perimeter	0.01~100.00cm	10.00cm	
F09.08	Length ratio	0.001~10.000	1.000	
F09.09	Length correcting coefficient	0.001~1.000	1.000	

F09.06 the number of pulse per rotation refers to outer rotating per revolution of shaft input the number of pluses to the AC drive.

F09.07 Alxe perimeter refers to the outer perimeter of external rotation axis.  
(Unit: cm)

The AC drive calculates total length = (Length calculated by pulse ) × F09.08 × F09.09.

Function Code	Name	Setting Range	Default	Property
F09.10	Set count value	F09.11~65535	0	○
F09.11	Designated count value	0~F09.10	0	○

The counter works by the input pulse signals of the HDI1 terminal.

When the counter achieves a fixed number, the multi-function output terminal will output the signal of “designated count value reached”, and the counter continues to working.

When the count value achieves a set count value, the multi-function output terminal will output the signal of “set count value reached”, the counter will clear all numbers and stop to recount before the next pulse. Designated count value F09.11 should be no more than the set count value F09.10.

The function is illustrated as below:

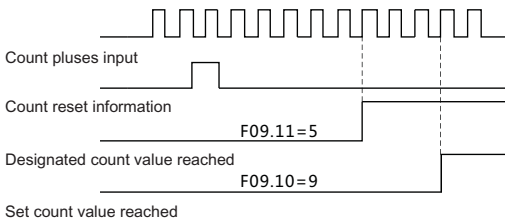

Function Code	Name	Setting Range	Default	Property
F09.12	Running time setting	0~65535min	0	○

Pre-set the running time of the AC drive. When the accumulative running time achieves the set time, the multi-function digital output terminals will output the signal of “Running time arrival”.

Function Code	Name	Setting Range	Default	Property
F09.13	Exact stop mode	0~2	0	○

0: Stop invalid

1: Setting length reached

2: Setting counter value reached

When F0A.13 is non-zero, the AC drive will stop according to the setting conditions.

### Group F0A Simple PLC and Multi-stage Speed Control

Function Code	Name	Setting Range	Default	Property
F0A.00	Simple PLC mode	0~2	0	○

0: Stop after the AC drive runs one cycle.

The AC drive stops after running one cycle, and will not start up until receiving another command.

1: Keep final value after the AC drive runs one cycle.

The AC drive keeps the final running frequency and direction after running one cycle.

2: Cycle running.

The AC drive automatically starts the next cycle after running one cycle, and will not stop until receiving the stop command.

Function Code	Name	Setting Range	Default	Property
F0A.01	Simple PLC retentive selection	0~1	0	○

0: No retentive upon power failure

1: Retentive upon power failure, PLC record the running stage and frequency when power failure.

Function Code	Name	Setting Range	Default	Property
F0A.02	Multi-stage speed 0	-100.0~100.0%	0.0%	○
F0A.03	The running time of step 0	0.0~6553.5s(min)	0.0s	○
F0A.04	Multi-stage speed 1	-100.0~100.0%	0.0%	○
F0A.05	The running time of step 1	0.0~6553.5s(min)	0.0s	○
F0A.06	Multi-stage speed 2	-100.0~100.0%	0.0%	○
F0A.07	The running time of step 2	0.0~6553.5s(min)	0.0s	○
F0A.08	Multi-stage speed 3	-100.0~100.0%	0.0%	○
F0A.09	The running time of step 3	0.0~6553.5s(min)	0.0s	○
F0A.10	Multi-stage speed 4	-100.0~100.0%	0.0%	○
F0A.11	The running time of step 4	0.0~6553.5s(min)	0.0s	○
F0A.12	Multi-stage speed 5	-100.0~100.0%	0.0%	○
F0A.13	The running time of step 5	0.0~6553.5s(min)	0.0s	○
F0A.14	Multi-stage speed 6	-100.0~100.0%	0.0%	○
F0A.15	The running time of step 6	0.0~6553.5s(min)	0.0s	○
F0A.16	Multi-stage speed 7	-100.0~100.0%	0.0%	○
F0A.17	The running time of step 7	0.0~6553.5s(min)	0.0s	○
F0A.18	Multi-stage speed 8	-100.0~100.0%	0.0%	○
F0A.19	The running time of step 8	0.0~6553.5s(min)	0.0s	○
F0A.20	Multi-stage speed 9	-100.0~100.0%	0.0%	○
F0A.21	The running time of step 9	0.0~6553.5s(min)	0.0s	○
F0A.22	Multi-stage speed 10	-100.0~100.0%	0.0%	○



Function Code	Name	Setting Range	Default	Property
F0A.23	The running time of step 10	0.0~6553.5s(min)	0.0s	○
F0A.24	Multi-stage speed11	-100.0~100.0%	0.0%	○
F0A.25	The running time of step 11	0.0~6553.5s(min)	0.0s	○
F0A.26	Multi-stage speed12	-100.0~100.0%	0.0%	○
F0A.27	The running time of step 12	0.0~6553.5s(min)	0.0s	○
F0A.28	Multi-stage speed13	-100.0~100.0%	0.0%	○
F0A.29	The running time of step 13	0.0~6553.5s(min)	0.0s	○
F0A.30	Multi-stage speed14	-100.0~100.0%	0.0%	○
F0A.31	The running time of step 14	0.0~6553.5s(min)	0.0s	○
F0A.32	Multi-stage speed15	-100.0~100.0%	0.0%	○
F0A.33	The running time of step 15	0.0~6553.5s(min)	0.0s	○

100% of the frequency setting corresponds to the maximum output frequency F00.03.

When selecting simple PLC running, set F0A.02 ~ F0A.33 to define the running frequency, direction and running time.

**Note:**

The symbol of Multi-stage determines the running direction of simple PLC.

The negative value means running in reverse rotation.

Multi-stage speed can be set continuously in the range of  $-f_{max} \sim f_{max}$ .

SD90 AC drives can set 16 stages speed, selected by combination of Multi-stage terminals 1~4, corresponding to Multi-stage speed 1 to speed 15.

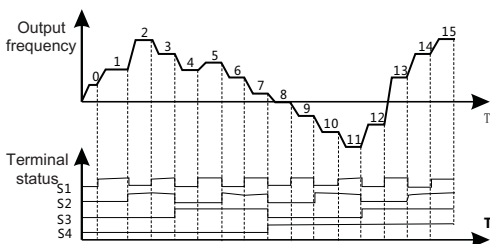

When both F00.06 and F00.07 are not equal to 5 (PLC setting) or 6 (Multi-stage speed setting), F00.06 and F00.07 are not equal to 7 (PID setting) or F08.00 (PID setting) is not equal to 4 (Multi-stage speed setting), the Multi-stage speeds take precedence over other setting. If S1, S2, S3 and S4 are OFF, the frequency input mode selected by F00.06 and F00.07. If S1, S2, S3 and S4 are not all OFF, it will run in Multi-stage speed. It can set 1~15 stage speed at most.

When one of the F00.06 and F00.07 is 6 or 7, the frequency input mode is selected by F00.06 and F00.07, the Multi-stage can set 0~15 stage speed.

S1	OFF	ON	OFF	ON	OFF	ON	OFF	ON	OFF	ON	OFF	ON	OFF	ON	OFF	ON
S2	OFF	OFF	ON	ON	OFF	OFF	ON	ON	OFF	OFF	ON	ON	OFF	OFF	ON	ON
S3	OFF	OFF	OFF	OFF	ON	ON	ON	ON	OFF	OFF	OFF	OFF	ON	ON	ON	ON
S4	OFF	OFF	OFF	OFF	OFF	OFF	OFF	OFF	ON	ON	ON	ON	ON	ON	ON	ON
STEP	0	1	2	3	4	5	6	7	8	9	10	11	12	13	14	15

6

The setting range of F0A.2n (1 < n < 17): -100.0~100.0%

The setting range of F0A.2n+1 (1 < n < 17): 0.0~6553.5s (s/min)

Function Code	Name	Setting Range	Default	Property
F0A.34	Simple PLC 0~7 step ACC/DEC time	0x000~0xFFFF	0x0000	○
F0A.35	Simple PLC 8~15 step ACC/DEC time	0x000~0xFFFF	0x0000	○

The setting range of F0A.2n (1 < n < 17): -100.0~100.0%

The setting range of F0A.2n+1 (1 < n < 17): 0.0~6553.5s (s/min)

Detailed Description Table

Function code	Binary bit		Segments	Acc/Dec time 1	Acc/Dec time 2	Acc/Dec time 3	Acc/Dec time 4
F0A.34	BIT1	BIT0	0	00	01	10	11
	BIT3	BIT2	1	00	01	10	11
	BIT5	BIT4	2	00	01	10	11
	BIT7	BIT6	3	00	01	10	11
	BIT9	BIT8	4	00	01	10	11
	BIT11	BIT10	5	00	01	10	11
	BIT13	BIT12	6	00	01	10	11
	BIT15	BIT14	7	00	01	10	11
F0A.35	BIT1	BIT0	8	00	01	10	11
	BIT3	BIT2	9	00	01	10	11
	BIT5	BIT4	10	00	01	10	11
	BIT7	BIT6	11	00	01	10	11
	BIT9	BIT8	12	00	01	10	11
	BIT11	BIT10	13	00	01	10	11
	BIT13	BIT12	14	00	01	10	11
	BIT15	BIT14	15	00	01	10	11

After users select the corresponding ACC/DEC time, the combining 16 binary bit can be changed into hexadecimal bit, and then set the corresponding function codes.

Function Code	Name	Setting Range	Default	Property
F0A.36	PLC restart mode selection	0x000~0xFFFF	0	⊙

0: Restart from the first step.

Stop during running (cause by the stop command ,fault or power failure), run from the first step after restart.

1: Continue to run from the stop frequency.

Stop during running (cause by stop command or fault), the AC drive will record the running time automatically, enter into the stage after restart and keep the remaining running at the setting frequency.

Function Code	Name	Setting Range	Default	Property
F0A.37	Multi-stage time unit	0: seconds 1: minutes	0	Ⓢ

0: Seconds

The running time of all steps is counted by second.

1: Minutes

The running time of all step is counted by minute.

## Group F0B Protection Parameter Group

Function Code	Name	Setting Range	Default	Property
F0B.00	Output phase loss protection	0~1	1	⊙

0: Invalid

1: Valid

Function Code	Name	Setting Range	Default	Property
F0B.01	Frequency decreasing at sudden power loss	0~1	0	⊙

0: Invalid

1: Valid

Function Code	Name	Setting Range	Default	Property
F0B.02	Frequency decreasing ratio at sudden power loss	0.00Hz/s~F00.03/ (Max. frequency)	10.00Hz/s	⊙

Setting range: 0.00Hz/s~F00.03/s (Max. output frequency)

When F0B.01=1, Frequency decreasing ratio at sudden power loss is valid. After the power loss of the grid, the bus voltage drops to the sudden frequency-decreasing point, the AC drive begins to decrease the running frequency at F0B.02 to make the drive in the state of generating feedback. The feedback energy can maintain the bus voltage at a certain voltage point (shown in the table below), which can avoid the drive malfunction due to bus undervoltage and free parking, especially for high inertia loads, motor coasts to stop after a long time to stop down, affecting the normal run. When the power grid timely recovery, the output frequency continues to run until the command frequency return to the normal state.

Voltage level	220V	380V
Frequency-decreasing point at sudden power loss	260V	460V

**Note :**

Adjust the parameter properly to avoid the stopping caused by AC drive protection during the switching of the grid.

Prohibition of input phase loss protection can enable this function.

Function Code	Name	Setting Range	Default	Property
F0B.03	Over-voltage stall protection	0~1	1	⊙

0: Invalid

1: Valid

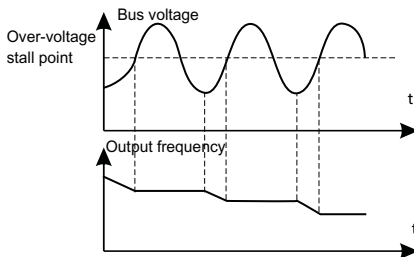

6

Function Code	Name	Setting Range	Default	Property
F0B.04	Voltage protection of over-voltage stall	120~150% (Standard bus voltage 220V)	120%	○
		120~150% (Standard bus voltage 380V)	125%	

This parameter sets over-voltage stall protection points. When the bus voltage exceeds the voltage of over-voltage protection point, the AC drive adjust output frequency to avoid the AC drive entering the generating state and then caused the increase of bus voltage. The frequency acceleration speed will further increase if the AC drive is in the acceleration state. The frequency output will increase if the AC drive is in a constant speed state. The frequency output will remain constant if the AC drive is in a deceleration state.

Function Code	Name	Setting Range	Default	Property
F0B.05	Current limit action selection	0~1	1	⊙
F0B.06	Automatic current limit	50.0~200.0%	Model Modification	⊙
F0B.07	Frequency-decreasing ratio during current limit	0.00~50.00Hz/s	10.00Hz/s	⊙

The actual increasing ratio of motor speed is lower than the ratio of output frequency because of big load during Accelerating running. It is necessary to take measures to avoid over-current fault and the AC drive trips.

During running of the AC drive, it will detect the output current and compare it with the current limit level defined in F0B.06. If it exceeds the current limit level, the AC drive will derate to run during the constant running. If it exceeds the level continuously, the output frequency will keep on decreasing to the lower limit. If the output current is detected to be lower than the current limit level, the drive will accelerate to run.

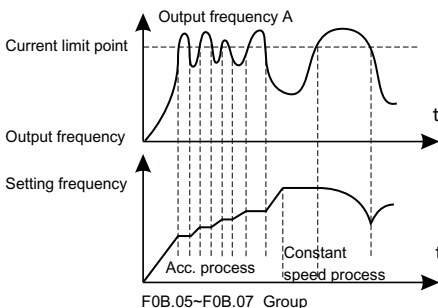

Function Code	Name	Setting Range	Default	Property
F0B.08	Reserve	0	0	●
F0B.09	Reserve	0	0	●
F0B.10	Reserve	0	0	●

Function Code	Name	Setting Range	Default	Property
F0B.11	Output terminal action during fault	0×00~0×11	0×00	○

F0B.11 Parameter Setting Function Table

Output Terminal Action During Fault Introductions	
LED ones	0: Action under fault undervoltage 1: No action under fault undervoltage
LED tens	0: Action during the automatic reset 1: No action during the automatic reset



## Group F0C Serial Communication Function Group

Function Code	Name	Setting Range	Default	Property
F0C.00	Local communication address	0~247 (0 is the broadcast address)	1	○

When the address of the machine is 0, the machine will be set up for the host, and send the running frequency of the broadcast machine transmission on the bus. When the host sends a frame address set to 0, that is broadcast frame, at this time all slaves will accept the frame, but the slave doesn't answer. The communication of the drive is unique in the communication net. This is the fundamental for the point to point communication between the upper monitor and the AC drive.

### Note:

The communication address of slave can not set to 0.

Function Code	Name	Setting Range	Default	Property
F0C.01	Communication baud ratio setting	0~5	4	○

0: 1200BPS

1: 2400BPS

2: 4800BPS

3: 9600BPS

4: 19200BPS

5: 38400BPS

### Note:

The baud rate of upper monitor and the AC drive must be same. Otherwise, the communication is not applied. The bigger the baud rate, the faster the communication speed is.

Function Code	Name	Setting Range	Default	Property
F0C.02	Digital bit checkout setting	0~5	1	○

- 0: No check (N, 8, 1) for RTU
- 1: Even check (E, 8, 1) for RTU
- 2: Odd check (O, 8, 1) for RTU
- 3: No check (N, 8, 2) for RTU
- 4: Even check (E, 8, 2) for RTU
- 5: Odd check (O, 8, 2) for RTU

**Note:**

The digital format between upper monitor and the AC drive must be the same. Otherwise, the communication is not applied.

Function Code	Name	Setting Range	Default	Property
F0C.03	Answer delay	0~200ms	5ms	○

The interval time when the drive receives the data and send it to the host. If the answer delay is shorter than the system processing time, then the answer delay time is the system processing time. If the answer delay is longer than the system processing time, then after the system deal with the data, waits until achieving the answer delay time to send the data to the host.

Function Code	Name	Setting Range	Default	Property
F0C.04	Fault time of communication overtime	0.0 (invalid), 0.1~60.0s	0.0s	○

When the function code is set to 0.0, the communication overtime parameter is invalid. When the function code is set as non-zero, if the interval time between two continuous communications exceeds the communication overtime, the system will report "485 communication fault" (CE). Generally, set it as invalid. Set the parameter in the continuous communication to monitor the communication state.

Function Code	Name	Setting Range	Default	Property
F0C.05	Transmission fault processing	0~3	0	○

0: Alarm and stop freely

1: No alarm and continue to run

2: No alarm and stop according to the stop mode (Only under the communication control)

3: No alarm and stop according to the mode (Under all control modes)

Function Code	Name	Setting Range	Default	Property
F0C.06	Communication processing action selection	0~1	0	○

0: Write with response.

The AC drive will respond to all reading and writing commands of the host.

1: Write without response.

The AC drive only responds to the reading command rather than the writing command of the drive. The communication efficiency can be increased by this method.

Function Code	Name	Setting Range	Default	Property
F0C.07	Host broadcast interval time	50ms-5000ms	50ms	○

When the machine is set as host, set the interval time between running frequency and start-stop commands which are the host send to the slave.

6

Function Code	Name	Setting Range	Default	Property
F0C.08	MODBUS communication mode selection	0~2	0	⊙

0: Standard RTU mode

When the local machine is slave (The address is non-zero) in this mode, the local machine receives and responds the reading and writing command of the host according to standard RTU protocol of MODBUS.

## 1: Host-slave mode 1

When the local machine is slave (The address is non-zero) in this mode, the local machine receives and responds the reading and writing command of the host according to standard RTU protocol of MODBUS. The host also can receive the frequency setting value which sends by broadcast command  $0 \times 20$  ( $0 \times 20$  command refers to chapter eight).

## 2: Host-slave mode 2

When the local machine is slave (The address is non-zero) in this mode, the local machine receives and responds the reading and writing command of the host according to standard RTU protocol of MODBUS. The host can receive both the frequency setting value and start-stop command which send by broadcast command  $0 \times 20$ .

**Note:**

This function code is valid only for non-zero local address. When address of the local machine is zero, the machine is set to the host and interval time of F0C.07 through  $0 \times 20$  command broadcasts frequency and start-stop command to the slave.

**Group F0D Status Check Function Group**

Function Code	Name	Setting Range	Default	Property
F0D.00	Setting frequency	0.00Hz~F00.03	0.00Hz	●
F0D.01	Output frequency	0.00Hz~F00.03	0.00Hz	●
F0D.02	Ramp reference frequency	0.00Hz~F00.03	0.00Hz	●
F0D.03	Output voltage	0~1200V	0V	●
F0D.04	Output current	0.0~5000.0A	0.0A	●
F0D.05	Motor rotational speed	0~65535rpm	0 rpm	●
F0D.06	Reserve	0	0	●
F0D.07	Reserve	0	0	●
F0D.08	Motor power	-300.0~300.0% (relative to motor rated power )	0.0%	●

Function Code	Name	Setting Range	Default	Property
F0D.09	Output torque	-250.0~250.0% (relative to motor rated torque )	0.0%	●
F0D.10	Evaluated motor frequency	0.00Hz~F00.03	0.00Hz	●
F0D.11	DC bus voltage	0.0~2000.0V	0V	●
F0D.12	Digital input terminals state	0000~001F	0	●
F0D.13	Digital output terminals state	0~3	0	●
F0D.14	Digital adjustment	0.00Hz~F00.03	0.00Hz	●
F0D.15	Reserve	0	0	●
F0D.16	Linear speed	0~65535	0	●
F0D.17	Length value	0~65535	0	●
F0D.18	Counting	0~65535	0	●
F0D.19	AI1 input voltage	0.00~10.00V	0.00V	●
F0D.20	Reserve	0	0	●
F0D.21	Reserve	0	0	●
F0D.22	HDI input frequency	0.00~50.00kHz	0.00kHz	●
F0D.23	PID reference value	-100.0~100.0%	0.0%	●
F0D.24	PID feedback value	-100.0~100.0%	0.0%	●
F0D.25	Power factor of the motor	-1.00~1.00	0.0	●
F0D.26	The running time	0-65535min	-	○
F0D.27	The current step of Multi-stage speed and PLC	0~15	0	●

All parameters of F0D group are display quantities. They are can be view, but can not be modified.





# Chapter 7

## **Maintenance and Troubleshooting**

---

### **7.1 Routine Repair and Maintenance of the SD90**

#### **7.1.1 Routine Maintenance**

The influence of the ambient temperature, humidity, dust and vibration will cause the aging of the devices in the AC drive, which may cause potential faults or reduce the service life of the AC drive. Therefore, it is necessary to carry out routine and periodic maintenance.

Routine maintenance involves checking:

- 1) Whether the motor sounds abnormally during running;
- 2) Whether the motor vibrates excessively during running;
- 3) Whether the installation environment of the AC drive changes ;
- 4) Whether the AC drive's cooling fan works normally;
- 5) Whether the AC drive overheats.

Routine cleaning involves:

- 1) Keep the AC drive clean all the time;
- 2) Remove the dust, especially mental powder on the surface of the AC drive, to prevent the dust from entering the AC drive;
- 3) Clear the oil stain on the cooling fan of the AC drive.

### 7.1.2 Periodic Inspection

Perform periodic inspection in places where inspection is difficult.

Periodic inspection involves:

- 1) Check and clean the air duct periodically;
- 2) Check whether the screws become loose;
- 3) Check whether the AC drive is corroded;
- 4) Check whether the wiring terminals show signs of arcing;
- 5) Main circuit insulation test.

#### Note:

Before measuring the insulating resistance with megameter 500VDC (megameter recommended), disconnect the main circuit from the AC drive. Do not use the insulating resistance meter to test the insulation of the control circuit. The high voltage test is unnecessary to perform again because it has been completed before delivery.

### 7.1.3 Replacement of Vulnerable Components

The vulnerable components of the AC drive are cooling fan and filter electrolytic capacitor. Their service life is related to the operating environment and maintenance status. Generally, the service life is shown as follows:

Component	Service life
Cooling fan	2 to 3 years
Electrolytic capacitor	4 to 5 years

#### Note:

Standard replacement time is the time under the following conditions, the user can determines the replacement life according to the running time.

- ♦ Ambient temperature: the annual average temperature is about 30 °C.
- ♦ Load rate: under 80%.
- ♦ Running rate: under 20 hours per day.
  - 1) Cooling fan
    - Possible damage reason: Bearing worn and blade aging;



- Judging criteria: whether there is crack on the blade; Whether there is abnormal vibration noise upon startup.

#### 2) Filter electrolytic capacitor

- Possible damage reason: Input power supply in poor quality; High ambient temperature; Frequent load jumping; and electrolyte aging.

- Judging criteria: Whether there is liquid leakage; Whether the safe value has projected; Measure the static capacitance; Measure the insulating resistance.

### 7.1.4 Storage of the AC drive

For storage of the AC drive, pay attention to the following two aspects:

1) Pack the AC drive with the original packing box provided by company

2) Long-term storage degrades the electrolytic capacitor. Thus, the AC drive must be energized once every two years, each time lasting at least 5 hours. The input voltage must be increased slowly to the rated value with the regulator.

## 7.2 Warranty Agreement

1) Free warranty only applies to the AC drive itself.

2) The company will provide 18-month warranty (Starting from the leave-factory date as indicated on the barcode) for the failure or damage under normal use conditions. If the equipment has been used for over 18 months, reasonable repair expenses will be charged.

3) Reasonable repair expenses will be charged for the damages due to the following causes:

a) Improper operation without following the instructions;

b) Cause damage by fire, flood or abnormal voltage, etc.

4) Using the AC drive for non-recommended function.

5) The maintenance fee is charged according to the manufacturer's uniform standard. If there is an agreement, the agreement prevails.

## 7.3 This chapter Content

This chapter describes how to reset faults and view fault history. It also lists all alarm and fault messages including the possible cause and corrective actions.

 **Danger**

- ✦ Only qualified professionals are allowed to maintain the AC drive. Read the safety instructions in chapter Safety precautions before working on the drive.

## 7.4 Alarm and Fault Indications

The fault code displays on the keypad indicates AC drive in a abnormal status. Using the information given in this chapter, most alarm and fault causes can be identified and corrected. If not, please contact the manufacturer.

## 7.5 Fault Reset

The AC drive can be reset By pressing the key STOP / RESET on the keypad, through digital input, or by switching the power supply, etc. When the fault has been removed, the motor can be restarted.

## 7.6 Fault History

Function codes F06.18 ~ F06.20 record three recent faults. Function codes F06.21 ~ F06.36 show drive operation data at the time the latest two faults occurred.

## 7.7 AC Drive Fault Instructions and Solutions

Do as the following after the AC drive fault:

- 1: Ensure there is nothing wrong with keypad. If not, please contact with the company and local offices.
- 2: If there is nothing wrong, please check F06 and ensure the corresponding recorded fault parameters to confirm the real state when the current fault occurs by all parameters.
- 3: See the following table for detailed solution and check the corresponding abnormal state.
- 4: Eliminate the fault or ask for relative help.
- 5: Check to eliminate the fault and carry out fault reset to run the AC drive.

No	Fault Code	Fault Type	Possible Causes	Solutions
1	E.oU1	Accelerating overvoltage	<ul style="list-style-type: none"> <li>◆ Input voltage is abnormal;</li> <li>◆ There is large energy feedback.</li> </ul>	<ul style="list-style-type: none"> <li>◆ Check the input power;</li> <li>◆ Check if the DEC time of the load is too short, or the AC drive starts during the rotation of the motor or it needs to increase the energy consumption components.</li> </ul>
2	E.oU2	Decelerating overvoltage		
3	E.oU3	Constant overvoltage		
4	E.oc1	Accelerating overcurrent	<ul style="list-style-type: none"> <li>◆ The acceleration and deceleration is too fast;</li> <li>◆ The voltage of grid is too low;</li> <li>◆ The power of AC drive is too low;</li> <li>◆ The load transients or is abnormal;</li> <li>◆ The grounding is short circuited and the output is phase loss;</li> <li>◆ There is a strong external interference</li> </ul>	<ul style="list-style-type: none"> <li>◆ Increase the ACC and DEC time;</li> <li>◆ Check the input power;</li> <li>◆ Select the AC drive with a larger power;</li> <li>◆ Check if the load is short circuited (the grounding short circuited or the wire short circuited) or the rotation is not smooth;</li> <li>◆ Check the output configuration;</li> <li>◆ Check if there is strong interference.</li> </ul>
5	E.oc2	Decelerating overcurrent		
6	E.oc3	Constant overcurrent		
7	E.LU	Bus undervoltage fault	<ul style="list-style-type: none"> <li>◆ The voltage of power supply is too low.</li> </ul>	<ul style="list-style-type: none"> <li>◆ Check the input power of the supply line</li> </ul>
8	E.oL1	Motor overload	<ul style="list-style-type: none"> <li>◆ The voltage of power supply is too low;</li> <li>◆ The motor setting rated current is incorrect;</li> <li>◆ The motor stall or load transients is too strong.</li> </ul>	<ul style="list-style-type: none"> <li>◆ Check voltage of power supply</li> <li>◆ Reset the rated current of the motor;</li> <li>◆ Check the load and adjust torque boost.</li> </ul>
9	E.oL2	The AC drive overload	<ul style="list-style-type: none"> <li>◆ The acceleration is too short;</li> <li>◆ Reset the rotating motor;</li> <li>◆ The voltage of power supply is too low;</li> <li>◆ The load is too heavy;</li> <li>◆ Close loop vector control, reverse direction of the code panel and long low-speed operation.</li> </ul>	<ul style="list-style-type: none"> <li>◆ Increase the acceleration time;</li> <li>◆ Avoid restart after stopping;</li> <li>◆ Check the power of the supply line;</li> <li>◆ Select a AC drive with bigger power;</li> <li>◆ Select a proper motor.</li> </ul>
10	E.SP0	Output phase loss	<ul style="list-style-type: none"> <li>◆ U, V, W phase loss output (Or serious asymmetrical three-phase of the load).</li> </ul>	<ul style="list-style-type: none"> <li>◆ Check input power of supply line.</li> </ul>

No	Fault Code	Fault Type	Possible Causes	Solutions
11	E.oH1	IGBT module overheat	<ul style="list-style-type: none"> <li>◆ Ambient temperature is too high;</li> <li>◆ The time of overload running is too long.</li> </ul>	<ul style="list-style-type: none"> <li>◆ Lower ambient temperature</li> </ul>
12	E.EF	External fault	<ul style="list-style-type: none"> <li>◆ Sn external fault input terminals action</li> </ul>	<ul style="list-style-type: none"> <li>◆ Check input power of supply line</li> </ul>
13	E.CE	485 communication fault	<ul style="list-style-type: none"> <li>◆ The baud rate setting is incorrect;</li> <li>◆ Communication wire failure;</li> <li>◆ The communication address is wrong;</li> <li>◆ There is strong interference to the communication.</li> </ul>	<ul style="list-style-type: none"> <li>◆ Set proper baud rate;</li> <li>◆ Check the communication interface wiring;</li> <li>◆ Set the correct communication address</li> <li>◆ Replace or change the wiring, improve anti-interference capability.</li> </ul>
14	E.lcE	Current detecting fault	<ul style="list-style-type: none"> <li>◆ The connection of control board is not good;</li> <li>◆ Hoare components are broken;</li> <li>◆ The modifying circuit is abnormal.</li> </ul>	<ul style="list-style-type: none"> <li>◆ Check the connector and repatch;</li> <li>◆ Replace Hoare current sensor;</li> <li>◆ Replace the main control board.</li> </ul>
15	E.EEP	EEPROM operation fault	<ul style="list-style-type: none"> <li>◆ There is an error in read-write control parameter;</li> <li>◆ EEPROM is damaged.</li> </ul>	<ul style="list-style-type: none"> <li>◆ Press STOP/RST to reset;</li> <li>◆ Replace the main control board</li> </ul>
16	E.PId	PID feedback disconnection fault	<ul style="list-style-type: none"> <li>◆ PID feedback offline;</li> <li>◆ PID feedback source disappear.</li> </ul>	<ul style="list-style-type: none"> <li>◆ Check the PID feedback signal;</li> <li>◆ Check the PID feedback source.</li> </ul>
17	E.BrE	Braking unit fault	<ul style="list-style-type: none"> <li>◆ Braking circuit fault or damage to the brake pipes;</li> <li>◆ External braking resistor is not sufficient.</li> </ul>	<ul style="list-style-type: none"> <li>◆ Check the braking unit and replace the braking pipe;</li> <li>◆ Increase the braking resistor.</li> </ul>
18	E.End	Running time reached	<ul style="list-style-type: none"> <li>◆ The actual running time is longer than the internal setting running time.</li> </ul>	<ul style="list-style-type: none"> <li>◆ Ask for the supplier and adjust the setting running time.</li> </ul>

## 7.8 Common Faults and Solutions

You may come across the following faults during the use of the AC drive. Refer to the following table for simple fault analysis.

No	Fault	Possible Causes	Solutions
1	No display at power-on	<ul style="list-style-type: none"> <li>◆ There is no power supply to the AC drive or the power Input to the AC drive is too low;</li> <li>◆ The power supply of the switch on the AC drive board is faulty;</li> <li>◆ The rectifier bridge is damaged;</li> <li>◆ Buffer resistance of the drive is damaged;</li> <li>◆ Control board and keypad are faulty;</li> <li>◆ The cable connecting the control board and the drive board and the operation panel breaks.</li> </ul>	<ul style="list-style-type: none"> <li>◆ Check the input supply;</li> <li>◆ Check the bus voltage;</li> <li>◆ Reconnect the driver board and the control board 26-core cable;</li> <li>◆ Contact the agent for technical support.</li> </ul>
2	is displayed at power-on	<ul style="list-style-type: none"> <li>◆ The cable between the driver board and the control board is not good;</li> <li>◆ Related components on the board are damaged.</li> </ul>	<ul style="list-style-type: none"> <li>◆ Re-connect the driver board and the control board 26-core cable;</li> <li>◆ Contact the agent for technical support.</li> </ul>
3	Display is normal upon power-on. But "SD90" is displayed after running and stops immediately.	<ul style="list-style-type: none"> <li>◆ The cooling fan is damaged or locked-rotor occurs;</li> <li>◆ The peripheral control terminal cable is short circuited.</li> </ul>	<ul style="list-style-type: none"> <li>◆ Replace the damaged fan;</li> <li>◆ Eliminate external short circuited fault.</li> </ul>
4	E.oH1 (module overheat) fault is reported frequently	<ul style="list-style-type: none"> <li>◆ The setting of carrier frequency is too high;</li> <li>◆ The cooling fan is damaged, or the air filter is blocked;</li> <li>◆ Components inside the AC drive are damaged (thermal coupler or others).</li> </ul>	<ul style="list-style-type: none"> <li>◆ Reduce the carrier frequency (F00.15);</li> <li>◆ Replace the fan and clean the air filter;</li> <li>◆ Contact the agent or our company for technical support</li> </ul>
5	The motor does not rotate after the AC drive runs	<ul style="list-style-type: none"> <li>◆ Motor and motor cable are faulty;</li> <li>◆ Motor nameplate parameters are set improperly;</li> <li>◆ The cable between the drive board and the control board is in poor contact;</li> </ul>	<ul style="list-style-type: none"> <li>◆ Ensure the cable between the AC drive and the motor is normal;</li> <li>◆ Replace the motor or clear mechanical faults;</li> </ul>

No	Fault	Possible Causes	Solutions
5	The motor does not rotate after the AC drive runs	<ul style="list-style-type: none"> <li>◆ The drive board is faulty.</li> </ul>	<ul style="list-style-type: none"> <li>◆ Check and re-set the motor nameplate parameters;</li> <li>◆ Check the cable between drive board and control panel;</li> <li>◆ Contact the agent or our company for technical support.</li> </ul>
6	Input Sn terminals are invalid	<ul style="list-style-type: none"> <li>◆ The parameters are set incorrectly;</li> <li>◆ The external signal is incorrect;</li> <li>◆ The control board is faulty.</li> </ul>	<ul style="list-style-type: none"> <li>◆ Reset the parameters in group F04;</li> <li>◆ Re-connect the external signal cables;</li> <li>◆ Contact the agent or our company for technical support.</li> </ul>
7	The AC drive reports over-current and over-voltage frequently	<ul style="list-style-type: none"> <li>◆ The motor nameplate parameters are set improperly;</li> <li>◆ The acceleration/ deceleration time is improper;</li> <li>◆ The load fluctuates.</li> </ul>	<ul style="list-style-type: none"> <li>◆ Re-set the motor nameplate parameters;</li> <li>◆ Set proper acceleration / deceleration time;</li> <li>◆ Contact the agent or our company for technical support.</li> </ul>



# Chapter 8

## **Communication protocol**

---

SD 90 series AC drives provide Rs485 communication interface and adopt MODBUS communication protocol. The users can realize centralized control (set the control command, modify and read function code parameters, read the operating state and fault messages of the AC drive and so on) through taking the PC or PLC as the host computer.

There are kinds of networking modes : single host / single slave mode and single host/multiple slaves mode.

## 8.1 Networking Mode

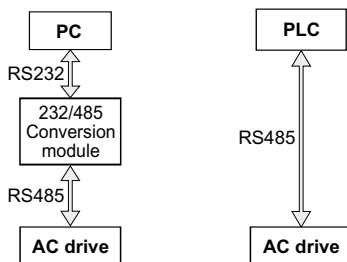

Fig. 7-1 Single host / single slave mode

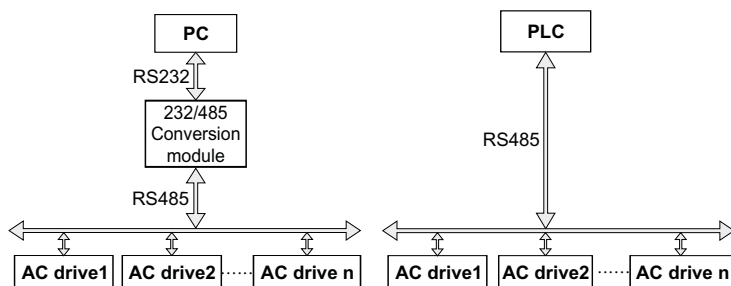

Fig. 7-2 Single host / multiple slaves mode

## 8.2 Interface mode

Rs485: Asynchronous, half duplex.

The default data format: E-8-1(Even check, 8 data bits, 1 end bit), 19200 BPS. The settings of communication parameters see F0B functional group.

## 8.3 Protocol Frame Format

MODBUS protocol includes two kinds of transmission modes (RTU mode and ASCII mode). SD90 drives only support TRU mode, the corresponding date format such as the followings.

Communication of bytes: 1 start bit,8 data bits, check bit, and end bit. When check bit, 1 even/odd check bit and 1 end bit. When no check bit, 2 end bits are existent.



Start bit	BIT 0	BIT 1	BIT 2	BIT 3	BIT 4	BIT 5	BIT 6	BIT 7	Check bit	Stop bit
-----------	-------	-------	-------	-------	-------	-------	-------	-------	-----------	----------

In the RTU mode, a new frame is always at least 3.5 bytes transmission time interval as a start. Transmission of the data fields in the order: Slave address, operation command code, data and CRC check. Transmission of each byte is hexadecimal. The data frame format as follows:

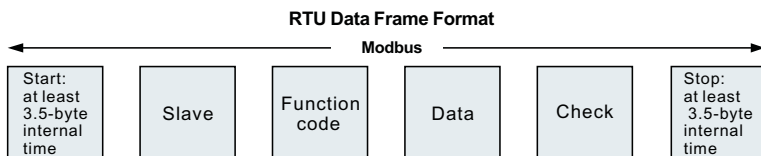

- (1) The head of frame and tail frame through the bus free time greater than or equal to 3.5-byte time to defined frame.
- (2) The idle time between bits must be smaller than 1.5 character communication time. Otherwise, the new receiving characters will be treat as the new frame head.
- (3) Data check adopts CRC-16 and the information of the frame participate in checking. The high-low byte of checksum needs to exchange before sending.
- (4) Bus idle time between frames keeps at least 3.5 bytes. The idle time between frames is unnecessary to accumulative start and end idle time.

## 8.4 Function Protocol

### (1) Read single or multiple data (0x03)

Slave ADDR	xx
CMD	0x03
High bit of the start bit	xx
Low bit of the start bit	xx
High bit of data number	xx
Low bit of data number	xx
Low bit of CRC check	xx
High bit of CRC check	xx

Read data : Slave responding frame

Slave ADDR	xx
CMD	0x03
Byte number N*2	N*2
High bit of data 1	xx
Low bit of data 1	xx
.....	xx
High bit of data N	xx
Low bit of data N	xx
Low bit of CRC check	xx
High bit of CRC check	xx

## (2) Write a single data (0x06)

Slave ADDR	xx
CMD	0x06
High bit of register Addr.	xx
Low bit of register Addr.	xx
High bit of write data	xx
Low bit of write data	xx
Low bit of CRC check	xx
High bit of CRC check	xx

Write Data response:

Slave ADDR	xx
CMD	0x06
High bit of register Addr.	xx
Low bit of register Addr.	xx
High bit of write data	xx
Low bit of write data	xx
Low bit of CRC check	xx
High bit of CRC check	xx

Read data: Slave response message

Slave ADDR	xx
CMD	0x20
High bit of start-stop command	xx
Low bit of start-stop command	xx
High bit of setting frequency value	xx
Low bit of setting frequency value	xx
Low bit of CRC check	xx
High bit of CRC check	xx

Slave no response.

### (3) Error message response

Sometimes, errors occurs during the process of the communication. For example, reading or writing data to an illegal address, etc., then the slave will not work as a normal read-write response to reply the host, but send a wrong message frame. Error message frame format is as follows, where the command code is the result of the operation between highest-bit (Bit 7) of host operation and 1 ( read error is 0x83 / write error is 0x86).

Slave Add	xx
CMD	0x83 or 0x86
Error code	xx
Low bit of CRC check	xx
High bit of CRC check	xx

**Error codes are defined as follows:**

Error Code	Error Name	Detailed Explanation of the Error
0x01	Illegal CMD	Slave received command code is illegal or not exist.
0x02	Illegal Add.	Slave receives operation address is cross-border or illegal.
0x03	Illegal Data	It is illegal that the salve receives data is not within the set range or the range is limited by other function.
0x04	Operation failed	Invalid for the function setting during the writing operation of the parameter, such as the function of the input terminals cannot be defined repeatedly.

Error Code	Error Name	Detailed Explanation of the Error
0x05	Password Error	Written password is different from password set by the user.
0x06	Data frame error	Slave received data frame length is incorrect or CRC checksum can not be pass.
0x07	Parameters only for read	Slave received the function parameters of the write operation is a read-only parameter.
0x08	Parameters can not be modified during running	Slave receives the function parameter of write operation can not be modified during running.
0x09	Password protection	Slave has set a user password, but there is no password verification

#### (4) CRC check

The CRC field is two bytes, including 16 figure binary values. It is added to the frame after calculated by transmitting device. The receiving device recalculates the CRC of the received frame and compares them with the value in the received CRC field. If the two value are different, there is an error in the communication.

First, transfer a 16 bit register. Then, deal with the continuous 8 bytes in the message and the value in the register. Only the 8Bit data in every character is valid on CRC, while the start and the end bit and the odd and even check bit are invalid.

Every 8-bit character is single exclusive or (XOR) with the CRC register data , the result moves to the lowest valid bit , the highest valid bit is filled with 0. LSB is distilled and detected. If LSB is 1, the CRC register is single exclusive with preset value. If LSB is 0, nothing happens. The whole process needs to repeat for 8 times. When the last bit (8th bit) finished, the next 8-bit byte character is single exclusive with the CRC register current value. The ultima CRC register value is the value since all the byte of the message has been performed. When CRC is added into the message, low bit enters first, then high bit's turn. Here provided a simple function of CRC calculation for the reference:

```

unsigned int crc_cal_value(unsigned char*data_value,unsigned char data_
length)
{
int l;

```

```
unsigned int crc_cal_value(unsigned char*data_value,unsigned char data_
length)
{
int l;
unsigned int crc_value=0xffff;
while(data_length--)
{
crc_value^=*data_value++;
for(i=0;i<8;i++)
{
if(crc_value&0x0001) crc_value=(crc_value>>1)^0xa001;
else crc_value=crc_value>>1;
}
}
return(crc_value);
}
```

## 8.5 Communication Parameter Address

MODBUS communication includes read and write operations of function parameters and some special register's read and write operations. Special register includes control register, set registers, state registers, and factory information.

**(1) The Definition of Communication Parameter Address** The function code number and parameter label is the representation rule of the parameter address.

High byte: F00-F0D

Low byte: : 00-FF

For example, to access F04.13, the access address of the parameter is 0xF40D ;

Function code group	Absolute address	Function code group	Absolute address
Group F00	0x00	Group F01	0x01
Group F02	0x02	Group F03	0x03
Group F04	0x04	Group F05	0x05
Group F06	0x06	Group F07	0x07
Group F08	0x08	Group F09	0x09
Group F0A	0x0A	Group F0B	0x0B
Group F0C	0x0C	Group F0D	0x0D

Note: Due to EEPROM is stored frequently, it will reduce the life of the EEPROM, so some parameters don't need to store in the communication mode, as long as change the RAM value, the absolute address in the table corresponding to the parameter RAM address high post. To achieve this function, as long as the absolute address regard address high post

For example :

The parameter F04.13 is stored in EEPROM, and the address is represented as 0xF40D ;

The parameter F04.13 is not stored in the EEPROM, and the address is represented as 0x040D ;

The parameter F0A.05 is stored in EEPROM, and the address is represented as 0xFA05 ;

The parameter F0A.05 is not stored in the EEPROM, and the address is represented as 0x0A05 ;

Read of both EEPROM address and RAM address are valid.

n reading function code parameters, the user can only read a maximum of 16 consecutive addresses of parameters, more than 16 drive will return an error illegal data. When the write function parameters, you can only write a parameter. Users write function parameters, it should pay attention to the set value can not exceed the function parameter setting range; its function code set permissions attributes related function parameters, such as read-only parameter can not write, can not change operating parameters during operation can not be written; after the user to set a password without decrypting, so parameters can not write; user passwords and parameters self-learning can not write by communication. Otherwise, the drive will return to fault information.

## (2) Special register address definitions

Register	Function	Add	Setup description	R/W
Control Register	Control Word register	2000H	0001H : Forward running 0002H : Reverse running 0003H : Forward jog 0004H : Reverse jog 0005H : Deceleration stop 0006H : Free stop ( Emergency Stop ) 0007H : Fault reset 0008H : Jog stop 0009H : Pre-excitation	W
	Control Bit register	2001H	Bit0:=0 invalid=1 Forward running Bit1:=0 invalid=1 Reverse running Bit2:=0 invalid=1 Forward jog Bit3:=0 invalid=1 Reverse jog Bit4:=0 invalid=1 Deceleration stop Bit5:=0 invalid=1 Free stop	W
Control Register	Control Bit register	2001H	Bit6:=0 invalid=1 Fault reset Bit7=0 invalid=1 Jog stop Bit8=0 Pre-excitation	W
Setting Register	Setting frequency	3000H	0~Fmax(unit : 0.01Hz)	W
	PID reference	3001H	0~1000(1000 correspondence to100.0%)	W
	PID feedback	3002H	0~1000(1000 correspondence to100.0%)	W
	Virtual input terminal	3009H	0x0000~0x00FF	W
Control Register	Virtual output terminal	300AH	0x0000~0x000F	W
	Voltage setting value	300BH	0~1000(1000 correspondence to 100.0% )	W
	Analog output set	300CH	-1000~1000(1000 correspondence to100.0%)	W
Status Register	Status register 1	6000H	0001H:Forward running 0002H:Reverse running 0003H:Inverter in stopping 0004H:Inverter in fault 0005H:Inverter in OF0F	R
	Status register 2	6001H	Bit0 : =0 : isn't ready to run =1 : ready to run Bit1~2 : =00 : motor1 =01 : motor2 Bit3:=0: Asynchronous motor =1Synchronous motor Bit4:=0: No overload pre-warning=1:overload pre-warning Bit5~Bit6:=00: keyboard control =01:terminal control=10 : Communication control	R
	Fault Code	6002H	See Fault Type Description	R

Register	Function	Add	Setup description	R/W
Factory Information	Inverter model	8000H	SD90----0XD090	R
	Bar code 1	8001H	Range : 0000~FFFF	R
	Bar code 2	8002H	Range : 0000~FFFF	R
	Bar code 3	8003H	Range : 0000~FFFF	R
	Bar code 4	8004H	Range : 0000~FFFF	R
	Bar code 5	8005H	Range : 0000~FFFF	R
	Bar code 6	8006H	Range : 0000~FFFF	R

**Note:**

R is only for read, write is invalid and will report fault; W is only for write, read is invalid and will report fault

**(3) Special register address definitions****Control Word Register**

Control register is write-only register returns a value of 0 to the register sends a read command. With this register, the user can control the start and stop of the inverter fault reset. It should be noted that the control register only in F00.01 is set to Communication operation command channel (F00.01 is set to 2) write effective.

**Setting register**

Setting register group is write-only register ,returns a value is for 0 to the register bank sends a read command.

**Setting frequency**

By writing to this register, the user can set the running frequency of the inverter. Setup range is 0 ~ F00.03 (maximum frequency). In writing this register, the user should ensure that the frequency command is for MODBUS reference mode (F00.06 or F00.07 is set to 8) Otherwise, it returns an error message, the settings will not succeed.

**PID reference, PID feedback**

By writing these two registers, the user can set the PID reference value and return the PID feedback value, in order to achieve a corresponding process control, setting range is -1000 to 1000 (corresponding to -100.0 to 100.0%). In writing these two register, users should ensure that the PID frequency command reference mode (F00.06 or F00.07 is set to 7), and the PID reference need to ensure PID reference source is set to MODBUS (F08.00 to 5), PID feedback need to ensure PID feedback source is set to MODBUS (F08.02 3), otherwise it returns an error message, the settings will not succeed.about PID control related information, please see F09 Group Function detail.



### Virtual input terminals, virtual output terminal

By writing these two register, users can do some logic control by simulating the function of the input and output terminals . Virtual terminal input range is 0x00 ~ 0xFF, virtual output terminals range is 0x00 ~ 0x0F. When writing a virtual input terminal register, the user should ensure that the virtual terminal is set to MODBUS setting (F04.09 to 1), otherwise it returns an error message, the settings will not succeed. In this case the input terminal will be invalid, the system only receiving logic control as terminal functions from virtual input terminalthe input . Virtual output terminals in any case can be written and will not return an error message, but only the corresponding output terminal selection for the MODBUS communication virtual terminal output (F05.01, F05.03 23), write virtual output terminal register the corresponding to output terminals is valid.

### Voltage setting value

By writing to this register, the user can set under V / F control mode V / F curve is the voltage value at the custom. The setting range is from 0 to 1000 (corresponding to 0.0 to 100.0%). In writing this register, the user should ensure that the voltage setting channel is set to MODBUS (F03.13 7), otherwise it returns an error message, the settings will not succeed.

### Output analog setting

By writing to this register, the user can set the output of analog output AO, setting range is from 0 to 1000 (corresponding to 0.0% to 100.0%). Users should make sure that the analog output is selected for MODBUS set (F05.10 14), corresponding to the output of analog output .

### Status Register

Status register setup group is for read-only register, write command is sent to the register will report an illegal data address the error code. Users can register by reading the reorganization understand the operation status of the inverter to control the motor type, run the command mode, fault codes and other information. Interpret error codes please see Chapter 6.

### Factory Information

Manufacturers information register set to read-only register, write command is sent to the register will report an illegal data address the error code. Users can register by reading drive model to understand the type of inverter, SD90 models 0xD090. Manufacturers of bar code for maintenance and management of the inverter manufacturers for recording.

#### (4) MODBUS Communication Illustration

It is assumed that the SD90 AC drive is set to the communication command control mode, MODBUS start AC drive with 30.00Hz frequency reverse running and observe the running state.

Firstly, setting AC drive to communication command control mode(F00.01 is set to 3), and the communication channel is set to MODBUS communication (F00.02 is set to 2).

**Host send:** 01 06 00 01 00 02 59 CB  
**AC drive response:** 01 06 00 01 00 02 59 CB

Secondly, setting AC drive running frequency command selection is MODBUS (F00.06 is set to 8), and the setting running frequency is 30.00Hz. When the 30.00 Hz communication, it setting value is 0x0BBB(decimal is 3000).

**Host send:** 01 06 00 06 00 08 68 0D  
**AC drive response:** 01 06 00 06 00 08 68 0D

**Host send:** 01 06 30 00 0B B8 81 88  
**AC drive response:** 01 06 30 00 0B B8 81 88

Finally, star AC drive reverse running and read return to AC drive state.

**Host send:** 01 06 20 00 00 02 03 CB  
**AC drive response:** 01 06 20 00 00 02 03 CB

**Host send:** 01 03 60 00 00 01 9A 0A  
**AC drive response:** 01 03 02 00 02 39 85

Below is the testing report of serial interface adjusting, baud rate was set as 19200, digital bit is 8 bits, one even parity, one end bit. Connect AC drive with the COM interface of PC by convert RS232 into Rs485.

**串口调试软件 4.5**

端口: COM4 | 波特率: 19200 | 数据位: 8 | 校验位: 偶校验 | 停止位: 1

状态: ● 关闭串口

发送: ● 接收

清空接收区  16进制 | 停止显示  自动清 | 保存数据  更改文件

data.txt

清空计数  关于程序

文件行数  | 当前发送行

显示保存发送 |  显示保存时间 |  换行符 0x0A |  关键字过滤接收 | 关键字

```

[2015-07-23 16:12:15][发送]01 06 00 01 00 03 98 0B
[2015-07-23 16:12:15][接收]01 06 00 01 00 03 98 0B
[2015-07-23 16:12:22][发送]01 06 00 02 00 00 28 0A
[2015-07-23 16:12:22][接收]01 06 00 02 00 00 28 0A
[2015-07-23 16:12:25][发送]01 06 00 06 00 09 A9 CD
[2015-07-23 16:12:25][接收]01 06 00 06 00 09 A9 CD
[2015-07-23 16:12:38][发送]01 06 30 00 0B B8 81 88
[2015-07-23 16:12:38][接收]01 06 30 00 0B B8 81 88
[2015-07-23 16:12:48][发送]01 06 20 00 00 02 03 CB
[2015-07-23 16:12:57][发送]01 03 60 00 00 01 9A 0A
[2015-07-23 16:12:57][接收]01 03 02 00 02 39 85

```

发送区1: 清空 | 手动发送 | 01 06 30 00 0B B8 81 88

发送区2: 清空 | 手动发送 | 01 06 20 00 00 02 03 CB

发送区3: 清空 | 手动发送 | 01 03 60 00 00 01 9A 0A

发送区及发送文件轮发性

只轮发一遍 周期 1000 ms |  选择发送文件

收到回答后发下一帧 |  定时 开始文件轮发

超时时间 5 s | 重发次数 1 | 开始发送区轮发

发送区1属性

16进制 | 校验 |  自动发 |  参加轮发 | 发送周期  ms

发送区2属性

16进制 | 校验 |  自动发 |  参加轮发 | 发送周期  ms

发送区3属性

16进制 | 校验 |  自动发 |  参加轮发 | 发送周期  ms



# SINOVO

## Warranty Agreement

- ① The warranty period of the product is 18 months (refer to the bar code on the equipment body). During the warranty period , if the product fails or damaged under the condition of normal use by following the instruction, we will be responsible for free maintenance.
- ② Within the warranty period , maintenance will be charged for the damages caused by the following reasons :
  - ✧ The damage caused by improper use or repair/modification without prior permission.
  - ✧ The damage caused by fire , flood , abnormal voltage , other natural disasters and second disaster.
  - ✧ The hardware damage caused by artificial falling or transportation after purchase.
  - ✧ The damage caused by the improper operation.
  - ✧ The damage or failure caused by the trouble out of the equipment (e.g. : External device)
- ③ If there is any failure or damage to the product, please fill in the information of the Product Warranty Card in details correctly.
- ④ The maintenance fee is charged according to the newly adjusted Maintenance Price List of our company .
- ⑤ In general , the warranty card will not be re-issued. Please keep the card and present it to the maintenance personnel when asking for maintenance .
- ⑥ If there is any problem during the service , please contact the agent of our company or our company directly .

**SHENZHEN SINOVO ELECTRIC TECHNOLOGIES CO.,LTD.**  
**Service Department**

Add: 3rd Floor,No.B Building ,Huafeng Industrial Zone , Gushu Hangcheng Street ,  
Xixiang Town, Bao'an District, Shenzhen City,China

Tel: 0755-29784870

Sell Service Certer: 0755-29784875

Fax: 0755-29784873

P.C.: 518000

**SHENZHEN SINOVO ELECTRIC TECHNOLOGIES CO.,LTD.**

# SINOVO

## Product Warranty Card

<b>Customer information</b>	Add. of corporation:	
	Name of corporation:	Contact person:
	P.C.:	Tel.:
<b>Product information</b>	Product model:	
	Body bar code:	
	Name of agent:	
<b>Failure information</b>	(maintenance time and content):	
	Maintenance personnel:	